



US011902294B2

(12) **United States Patent**
Marty et al.

(10) **Patent No.:** **US 11,902,294 B2**
(45) **Date of Patent:** ***Feb. 13, 2024**

(54) **USING HUMAN FACTORS WHEN CALCULATING A RISK SCORE**

(71) Applicant: **Forcepoint, LLC**, Austin, TX (US)

(72) Inventors: **Raffael Marty**, Austin, TX (US);
Nicolas Christian Fischbach, Uitikon (CH)

(73) Assignee: **Forcepoint LLC**, Austin, TX (US)

(*) Notice: Subject to any disclaimer, the term of this patent is extended or adjusted under 35 U.S.C. 154(b) by 633 days.

This patent is subject to a terminal disclaimer.

(21) Appl. No.: **17/139,051**

(22) Filed: **Dec. 31, 2020**

(65) **Prior Publication Data**

US 2021/0152568 A1 May 20, 2021

Related U.S. Application Data

(63) Continuation of application No. 16/557,560, filed on Aug. 30, 2019, now Pat. No. 10,999,296, which is a (Continued)

(51) **Int. Cl.**
H04L 9/40 (2022.01)
G06F 21/56 (2013.01)
(Continued)

(52) **U.S. Cl.**
CPC **H04L 63/14** (2013.01); **G06F 21/566** (2013.01); **G06F 21/577** (2013.01);
(Continued)

(58) **Field of Classification Search**
CPC ... H04L 63/14; H04L 63/102; H04L 63/1416; H04L 63/1425; H04L 63/1433;
(Continued)

(56) **References Cited**

U.S. PATENT DOCUMENTS

6,072,875 A 6/2000 Tsudik
6,678,693 B1 1/2004 Shiraishi
(Continued)

FOREIGN PATENT DOCUMENTS

WO 2019153581 A1 8/2019

OTHER PUBLICATIONS

L. F. Lafuerza et al., Exact Solution of a Stochastic Protein Dynamics Model with Delayed Degradation, Phys. Rev. E 84, 051121, Nov. 18, 2011, pp. 1-8.

(Continued)

Primary Examiner — Darren B Schwartz

(74) *Attorney, Agent, or Firm* — Terrile, Cannatti & Chambers, LLP; Stephen A. Terrile

(57) **ABSTRACT**

A system, method, and computer-readable medium are disclosed for performing a security operation. The security operation includes: monitoring an entity, the monitoring observing at least one electronically-observable data source; deriving an observable based upon the monitoring of the electronically-observable data source; associating a human factor with the entity; identifying an event of analytic utility, the event of analytic utility being derived from the observable from the electronic data source; analyzing the event of analytic utility, the analyzing the event of analytic utility taking into account the human factor associated with the entity enacting the event of analytic utility; generating a risk score in response to the analyzing, the risk score taking into account the human factor associated with the entity; and, performing the security operation when the risk score meets a security risk parameter.

17 Claims, 28 Drawing Sheets

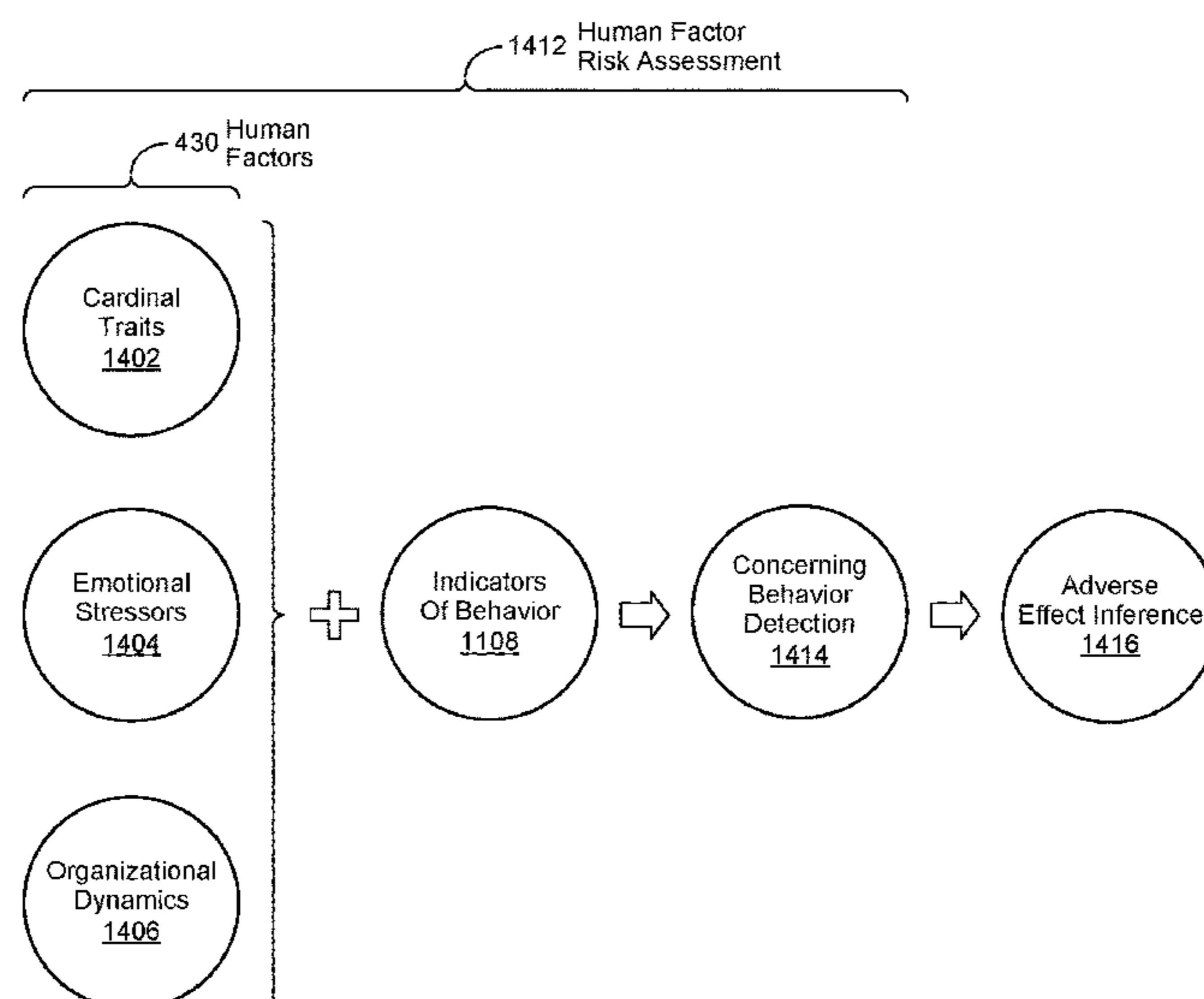

Related U.S. Application Data

continuation-in-part of application No. 16/415,726, filed on May 17, 2019, now Pat. No. 10,834,097, application No. 17/139,051 is a continuation-in-part of application No. 16/162,655, filed on Oct. 17, 2018, now Pat. No. 10,530,786, which is a continuation of application No. 15/963,729, filed on Apr. 26, 2018, now Pat. No. 10,129,269, which is a continuation-in-part of application No. 15/878,898, filed on Jan. 24, 2018, now Pat. No. 10,063,568, which is a continuation of application No. 15/720,788, filed on Sep. 29, 2017, now Pat. No. 9,882,918.

(60) Provisional application No. 63/119,116, filed on Nov. 30, 2020, provisional application No. 63/107,320, filed on Oct. 29, 2020, provisional application No. 63/017,400, filed on Apr. 29, 2020, provisional application No. 62/964,372, filed on Jan. 22, 2020, provisional application No. 62/839,060, filed on Apr. 26, 2019, provisional application No. 62/506,300, filed on May 15, 2017.

(51) **Int. Cl.**
G06F 21/57 (2013.01)
H04L 67/306 (2022.01)

(52) **U.S. Cl.**
 CPC *H04L 63/102* (2013.01); *H04L 63/1416* (2013.01); *H04L 63/1425* (2013.01); *H04L 63/1433* (2013.01); *H04L 63/205* (2013.01); *H04L 67/306* (2013.01); *G06F 2221/034* (2013.01)

(58) **Field of Classification Search**
 CPC H04L 63/205; H04L 67/306; H04L 63/20; G06F 21/566; G06F 21/577; G06F 2221/034
 See application file for complete search history.

(56) **References Cited**

U.S. PATENT DOCUMENTS

7,107,447 B2 9/2006 Sanin et al.
 7,694,150 B1 4/2010 Kirby
 7,725,565 B2 5/2010 Li et al.
 7,813,944 B1 10/2010 Luk et al.
 7,933,960 B2 4/2011 Chen et al.
 8,181,253 B1 5/2012 Zaitsev et al.
 8,312,064 B1 11/2012 Gauvin
 8,424,061 B2 4/2013 Rosenoer
 8,484,066 B2 7/2013 Miller et al.
 8,490,163 B1 7/2013 Harsell et al.
 8,713,633 B2 4/2014 Thomas
 8,776,168 B1 7/2014 Gibson et al.
 8,826,443 B1 9/2014 Raman et al.
 8,892,690 B2 11/2014 Liu et al.
 8,990,930 B2 3/2015 Burrell et al.
 9,015,812 B2 4/2015 Plattner et al.
 9,015,847 B1 4/2015 Kaplan et al.
 9,043,905 B1 5/2015 Allen et al.
 9,053,124 B1 6/2015 Dornquast et al.
 9,128,995 B1 9/2015 Fletcher et al.
 9,137,318 B2 9/2015 Hong
 9,166,999 B1 10/2015 Kulkarni et al.
 9,223,972 B1 12/2015 Vincent et al.
 9,246,941 B1 1/2016 Gibson et al.
 9,262,722 B1 2/2016 Daniel
 9,298,726 B1 3/2016 Mondal et al.
 9,338,187 B1 5/2016 Oprea et al.
 9,342,553 B1 5/2016 Fuller
 9,369,433 B1 6/2016 Paul et al.
 9,485,266 B2 11/2016 Baxley et al.

9,542,650 B2 1/2017 Lospinoso et al.
 9,596,146 B2 3/2017 Coates et al.
 9,609,010 B2 3/2017 Sipple
 9,665,854 B1 5/2017 Burger et al.
 9,680,938 B1 6/2017 Gil et al.
 9,692,762 B2 6/2017 Barkan et al.
 9,755,913 B2 9/2017 Bhide et al.
 9,762,582 B1 9/2017 Hockings et al.
 9,798,883 B1 10/2017 Gil et al.
 9,882,918 B1 1/2018 Ford et al.
 9,935,891 B1 4/2018 Stamos
 9,977,824 B2 5/2018 Agarwal et al.
 10,069,842 B1* 9/2018 Bradley H04L 63/0281
 10,096,065 B2 10/2018 Little
 10,108,544 B1 10/2018 Duggal et al.
 10,116,680 B1 10/2018 Han et al.
 10,187,369 B2 1/2019 Caldera et al.
 10,210,283 B2 2/2019 Broz et al.
 10,235,285 B1 3/2019 Wallace
 10,237,298 B1 3/2019 Nguyen et al.
 10,270,794 B1 4/2019 Mukerji et al.
 10,275,671 B1 4/2019 Newman
 10,282,702 B2 5/2019 Paltenghe et al.
 10,284,601 B1 5/2019 Bar-Menachem et al.
 10,320,813 B1 6/2019 Ahmed et al.
 10,341,391 B1 7/2019 Pandey et al.
 10,417,454 B1 9/2019 Marom et al.
 10,417,653 B2 9/2019 Milton et al.
 10,419,428 B2 9/2019 Tunnell et al.
 10,432,669 B1 10/2019 Badhwar et al.
 10,545,738 B1 1/2020 Jaeger et al.
 10,579,281 B2 3/2020 Cherubini et al.
 10,594,757 B1 3/2020 Shevchenko et al.
 10,713,934 B2 7/2020 Sayavong et al.
 10,754,936 B1 8/2020 Hawes et al.
 10,769,908 B1 9/2020 Burris et al.
 10,917,319 B2 2/2021 Scheib et al.
 10,958,673 B1 3/2021 Chen et al.
 11,061,874 B1 7/2021 Funk et al.
 11,329,998 B1 5/2022 Shahidzadeh et al.
 11,343,265 B2 5/2022 Lotem et al.
 2002/0112015 A1 8/2002 Haynes
 2002/0123865 A1 9/2002 Whitney et al.
 2004/0034582 A1 2/2004 Gilliam et al.
 2004/0044613 A1 3/2004 Murakami et al.
 2005/0120025 A1 6/2005 Rodriguez et al.
 2005/0198099 A1 9/2005 Motsinger et al.
 2005/0273850 A1 12/2005 Freund
 2006/0048209 A1 3/2006 Shelest et al.
 2006/0053476 A1 3/2006 Bezilla et al.
 2006/0112111 A1 5/2006 Tseng et al.
 2006/0117172 A1 6/2006 Zhang et al.
 2006/0129382 A1 6/2006 Anand et al.
 2006/0195905 A1 8/2006 Fudge
 2006/0206449 A1 9/2006 Fletcher et al.
 2006/0225124 A1 10/2006 Kolawa et al.
 2007/0043703 A1 2/2007 Bhattacharya et al.
 2007/0121522 A1 5/2007 Carter
 2007/0225995 A1 9/2007 Moore
 2007/0234409 A1 10/2007 Eisen
 2008/0168002 A1 7/2008 Kagarlis et al.
 2008/0168135 A1 7/2008 Redlich et al.
 2008/0168453 A1 7/2008 Hutson et al.
 2008/0198453 A1 8/2008 LaFontaine et al.
 2008/0244741 A1 10/2008 Gustafson et al.
 2009/0006888 A1 1/2009 Bernhard et al.
 2009/0177979 A1 7/2009 Garbow et al.
 2009/0182872 A1 7/2009 Hong
 2009/0228474 A1 9/2009 Chiu et al.
 2009/0300712 A1 12/2009 Kaufmann et al.
 2010/0024014 A1 1/2010 Kailash et al.
 2010/0057662 A1 3/2010 Collier et al.
 2010/0058016 A1 3/2010 Nikara et al.
 2010/0094767 A1 4/2010 Miltonberger
 2010/0094818 A1 4/2010 Farrell et al.
 2010/0107255 A1 4/2010 Eiland et al.
 2010/0146622 A1 6/2010 Nordstrom et al.
 2010/0205224 A1 8/2010 Palanisamy et al.
 2010/0228656 A1 9/2010 Wasserblat et al.

(56)

References Cited

U.S. PATENT DOCUMENTS

2010/0235495 A1	9/2010	Petersen et al.	2016/0224803 A1	8/2016	Frank et al.
2010/0275263 A1	10/2010	Bennett et al.	2016/0226914 A1	8/2016	Doddy et al.
2011/0061093 A1	3/2011	Korkus et al.	2016/0232352 A1	8/2016	Chen et al.
2011/0167105 A1	7/2011	Ramakrishnan et al.	2016/0232353 A1	8/2016	Gupta et al.
2011/0307957 A1	12/2011	Barcelo et al.	2016/0247158 A1	8/2016	Kolotinsky
2012/0046989 A1	2/2012	Baikalov et al.	2016/0261621 A1	9/2016	Srivastava et al.
2012/0047575 A1	2/2012	Baikalov et al.	2016/0277360 A1	9/2016	Dwyier et al.
2012/0079107 A1	3/2012	Williams et al.	2016/0277435 A1	9/2016	Salajegheh et al.
2012/0110087 A1	5/2012	Culver et al.	2016/0286244 A1	9/2016	Chang et al.
2012/0137367 A1	5/2012	Dupont et al.	2016/0300049 A1	10/2016	Guedalia et al.
2012/0210158 A1	8/2012	Akiyama et al.	2016/0308890 A1	10/2016	Weilbacher
2012/0258437 A1	10/2012	Sadeh-Konieczpol et al.	2016/0330219 A1	11/2016	Hasan
2012/0259807 A1	10/2012	Dymetman	2016/0330223 A1	11/2016	Sridhara et al.
2012/0290215 A1	11/2012	Adler et al.	2016/0330746 A1	11/2016	Mehrabanzad et al.
2013/0013550 A1	1/2013	Kerby	2016/0335865 A1	11/2016	Sayavong et al.
2013/0054433 A1	2/2013	Giard et al.	2016/0366167 A1*	12/2016	Yumer G06F 21/50
2013/0055367 A1	2/2013	Kshirsagar et al.	2016/0371489 A1	12/2016	Puri et al.
2013/0081141 A1	3/2013	Anurag	2017/0032274 A1	2/2017	Yu et al.
2013/0097662 A1	4/2013	Pearcy et al.	2017/0053280 A1	2/2017	Lishok et al.
2013/0097709 A1*	4/2013	Basavapatna H04L 63/1441 726/25	2017/0063888 A1	3/2017	Muddu et al.
			2017/0070521 A1	3/2017	Bailey et al.
			2017/0093904 A1*	3/2017	Ng H04L 63/20
			2017/0104790 A1	4/2017	Meyers et al.
			2017/0116054 A1	4/2017	Boddhu et al.
			2017/0155669 A1	6/2017	Sudo et al.
			2017/0171609 A1	6/2017	Koh
			2017/0230418 A1	8/2017	Amar et al.
			2017/0255938 A1	9/2017	Biegun et al.
			2017/0279616 A1	9/2017	Loeb et al.
			2017/0286671 A1*	10/2017	Chari G06F 21/552
			2017/0331828 A1	11/2017	Caldera et al.
			2017/0149815 A1	12/2017	Bolgert
			2018/0004948 A1	1/2018	Martin et al.
			2018/0007069 A1	1/2018	Hunt et al.
			2018/0018456 A1	1/2018	Chen et al.
			2018/0024901 A1	1/2018	Tankersley et al.
			2018/0025273 A1	1/2018	Jordan et al.
			2018/0027006 A1	1/2018	Zimmermann et al.
			2018/0081661 A1	3/2018	Gonzalez del Solar et al.
			2018/0082307 A1	3/2018	Ochs et al.
			2018/0091520 A1	3/2018	Camenisch et al.
			2018/0107528 A1	4/2018	Vizer et al.
			2018/0121514 A1	5/2018	Reisz et al.
			2018/0139227 A1	5/2018	Martin et al.
			2018/0145995 A1	5/2018	Roeh et al.
			2018/0150570 A1	5/2018	Broyd et al.
			2018/0191745 A1	7/2018	Moradi et al.
			2018/0191766 A1	7/2018	Holeman et al.
			2018/0191857 A1	7/2018	Schooler et al.
			2018/0204215 A1	7/2018	Hu et al.
			2018/0232111 A1	8/2018	Jones et al.
			2018/0232426 A1	8/2018	Gomez et al.
			2018/0234434 A1	8/2018	Viljoen
			2018/0248863 A1	8/2018	Kao et al.
			2018/0276541 A1	9/2018	Studnitzer et al.
			2018/0285363 A1	10/2018	Dennis et al.
			2018/0288063 A1	10/2018	Koottayi et al.
			2018/0295141 A1	10/2018	Solotorevsky
			2018/0316704 A1	11/2018	Joseph Durairaj et al.
			2018/0332054 A1	11/2018	Ford
			2018/0332062 A1	11/2018	Ford
			2018/0332063 A1	11/2018	Ford
			2018/0336353 A1	11/2018	Manadhata et al.
			2018/0341758 A1	11/2018	Park et al.
			2018/0341889 A1	11/2018	Psalmonds et al.
			2018/0349221 A1	12/2018	Harutyunyan et al.
			2018/0349606 A1	12/2018	Zhang et al.
			2018/0349684 A1	12/2018	Bapat et al.
			2018/0365619 A1*	12/2018	Hardy G06F 21/6254
			2019/0014137 A1	1/2019	Du et al.
			2019/0014153 A1	1/2019	Lang et al.
			2019/0020676 A1	1/2019	Laughlin et al.
			2019/0028557 A1	1/2019	Modi et al.
			2019/0034625 A1	1/2019	Ford et al.
			2019/0034813 A1	1/2019	Das et al.
			2019/0036969 A1	1/2019	Swafford et al.
			2019/0036971 A1	1/2019	Ford et al.
			2019/0052660 A1	2/2019	Cassidy et al.
			2019/0095478 A1	3/2019	Tankersley et al.
2016/0021117 A1	1/2016	Harmon et al.			
2016/0036844 A1	2/2016	Kopp et al.			
2016/0078362 A1	3/2016	Christodorescu et al.			
2016/0092774 A1	3/2016	Wang et al.			
2016/0105334 A1	4/2016	Boe et al.			
2016/0117937 A1	4/2016	Penders et al.			
2016/0147380 A1	5/2016	Coates et al.			
2016/0164922 A1	6/2016	Boss et al.			

(56)

References Cited

U.S. PATENT DOCUMENTS

2019/0158503	A1	5/2019	Bansal et al.
2019/0174319	A1	6/2019	Backholm et al.
2019/0222603	A1	7/2019	Yang
2019/0260777	A1*	8/2019	Mehrotra H04L 63/08
2019/0260794	A1	8/2019	Woodford et al.
2019/0289021	A1	9/2019	Ford
2019/0294482	A1	9/2019	Li et al.
2019/0306170	A1	10/2019	Wang et al.
2019/0311105	A1	10/2019	Beiter et al.
2019/0349391	A1	11/2019	Elsner et al.
2019/0354703	A1	11/2019	Ford
2019/0356688	A1	11/2019	Ford
2019/0356699	A1	11/2019	Ford
2019/0387002	A1	12/2019	Ford et al.
2019/0387003	A1	12/2019	Ford et al.
2019/0392419	A1	12/2019	DeLuca et al.
2020/0021620	A1	1/2020	Purathepparambil et al.
2020/0034462	A1	1/2020	Narayanawamy et al.
2020/0036740	A1	1/2020	Ford
2020/0065728	A1	2/2020	Wilson et al.
2020/0077265	A1	3/2020	Singh et al.
2020/0089692	A1	3/2020	Tripathi et al.
2020/0117546	A1	4/2020	Wong et al.
2020/0202343	A1	6/2020	Shi et al.
2020/0259852	A1	8/2020	Wolff et al.
2020/0334025	A1	10/2020	Wang et al.
2021/0133298	A1	5/2021	Andrews et al.
2021/0273976	A1	9/2021	Reiser et al.
2021/0360027	A1	11/2021	Boyer et al.

OTHER PUBLICATIONS

Zoubin Ghahramani, Bayesian nonparametrics and the probabilistic approach to modelling, *Philosophical Transactions A of the Royal Society*, vol. 371 Issue: 1984, Published Dec. 31, 2012, pp. 1-20.

Elena Zheleva et al., Higher-order Graphical Models for Classification in Social and Affiliation Networks, *NIPS 2010 Workshop on Networks Across Disciplines: Theory and Applications*, Whistler BC, Canada, 2010, pp. 1-7.

Varun Chandola et al., Anomaly Detection: A Survey, *ACM Computing Surveys*, vol. 41, No. 3, Article 15, Jul. 2009, pp. 15.1-58.1.

Judea Pearl, The Causal Foundations of Structural Equation Modeling, Technical Report R-370, Computer Science Department, University of California, Los Angeles, also Chapter 5, R. H. Hoyle (Ed.), *Handbook of Structural Equation Modeling*, New York, Guilford Press, Jun. 4, 2012, pp. 68-91.

Yueh-Hsuan Chiang, Towards Large-Scale Temporal Entity Matching, Dissertation Abstract, University of Wisconsin-Madison, 2013.

Furong Li, Linking Temporal Records for Profiling Entities, 2015, SIGMOD '15 Proceedings of the 2015 ACM SIGMOD International Conference on Management of Data, pp. 593-605, <https://users.soe.ucsc.edu/~tan/papers/2015/modf445-li.pdf>.

Peter Christen et al., Adaptive Temporal Entity Resolution on Dynamic Databases, Apr. 2013, <http://users.cecs.anu.edu.au/~Peter.Christen/publications/christen2013pakdd-slides.pdf>.

Wikipedia, Categorical Distribution, edited Jul. 28, 2018, https://en.wikipedia.org/wiki/Categorical_distribution.

Wikipedia, One-Hot, edited May 22, 2018, <https://en.wikipedia.org/wiki/One-hot>.

S. Chambi et al., Better bitmap performance with Roaring bitmaps, arXiv:1402.6407v10 [cs.DB] (Mar. 15, 2016).

Jianguo Wang et al., An Experimental Study of Bitmap Compression vs. Inverted List Compression, SIGMOD 2017: Proceedings of the 2017 ACM Int'l Conf. on Management of Data, pp. 993-1008 (May 2017).

Barrere et al., Vulnerability Assessment in Autonomic Networks and Services: A Survey, *IEEE*, Aug. 30, 2013, vol. 16, issue. 2, pp. 988-1004.

Burns et al., Automatic Management of Network Security Policy, *IEEE*, Jun. 14, 2001, pp. 12-26.

Singh et al., Container-Based Microservice Architecture for Cloud Applications, *International Conference on Computing, Communication and Automation (ICCCA2017)*, 2017.

Sean Barnum, Standardized Cyber Threat Intelligence Information with the Structured Threat Information expression (STIX) Whitepaper v1.1 (Feb. 20, 2014).

Xiang Sun et al., Event Detection in Social Media Data Streams, *IEEE International Conference on Computer and Information Technology; Ubiquitous Computing and Communications; Dependable, Automatic and Secure Computing; Persuasive Intelligence and Computing*, pp. 1711-1717, Dec. 2015.

Mesaros et al., Latent Semantic Analysis in Sound Event Detection, *19th European Signal Processing Conference (EUSIPCO 2011)*, pp. 1307-1311, 2011.

Crandall et al., Inferring Social Ties from Geographic Coincidences, *PNAS*, vol. 107, No. 52, 2010, pp. 22436-22441, 2010.

Ross et al., Bully Prevention in Positive Behavior Support, *Journal of Applied Behavior Analysis*, 42(4), pp. 747-759, 2009.

Matt Klein, How to Erase Your iOS Device After Too Many Failed Passcode Attempts, <https://www.howtogeek.com/264369/how-to-erase-your-ios-device-after-too-many-failed-passcode-attempts/>, Jul. 28, 2016.

Github, The Z3 Theorem Prover, retrieved from internet May 19, 2020, <https://github.com/Z3Prover/z3>.

John Backes et al., Semantic-based Automated Reasoning for AWS Access Policies using SMT, *2018 Formal Methods in Computer Aided Design (FMCAD)*, Oct. 30-Nov. 2, 2018 https://d1.awsstatic.com/Security/pdfs/Semantic_Based_Automated_Reasoning_for_AWS_Access_Policies_Using_SMT.pdf.

Sanjeev Goyal et al, Attack, Defence and Contagion in Networks, *the Review of Economic Studies*, vol. 81, Issue 4, Oct. 2014, pp. 1518-1542, <https://doi.org/10.1093/restud/rdu013> (2014).

* cited by examiner

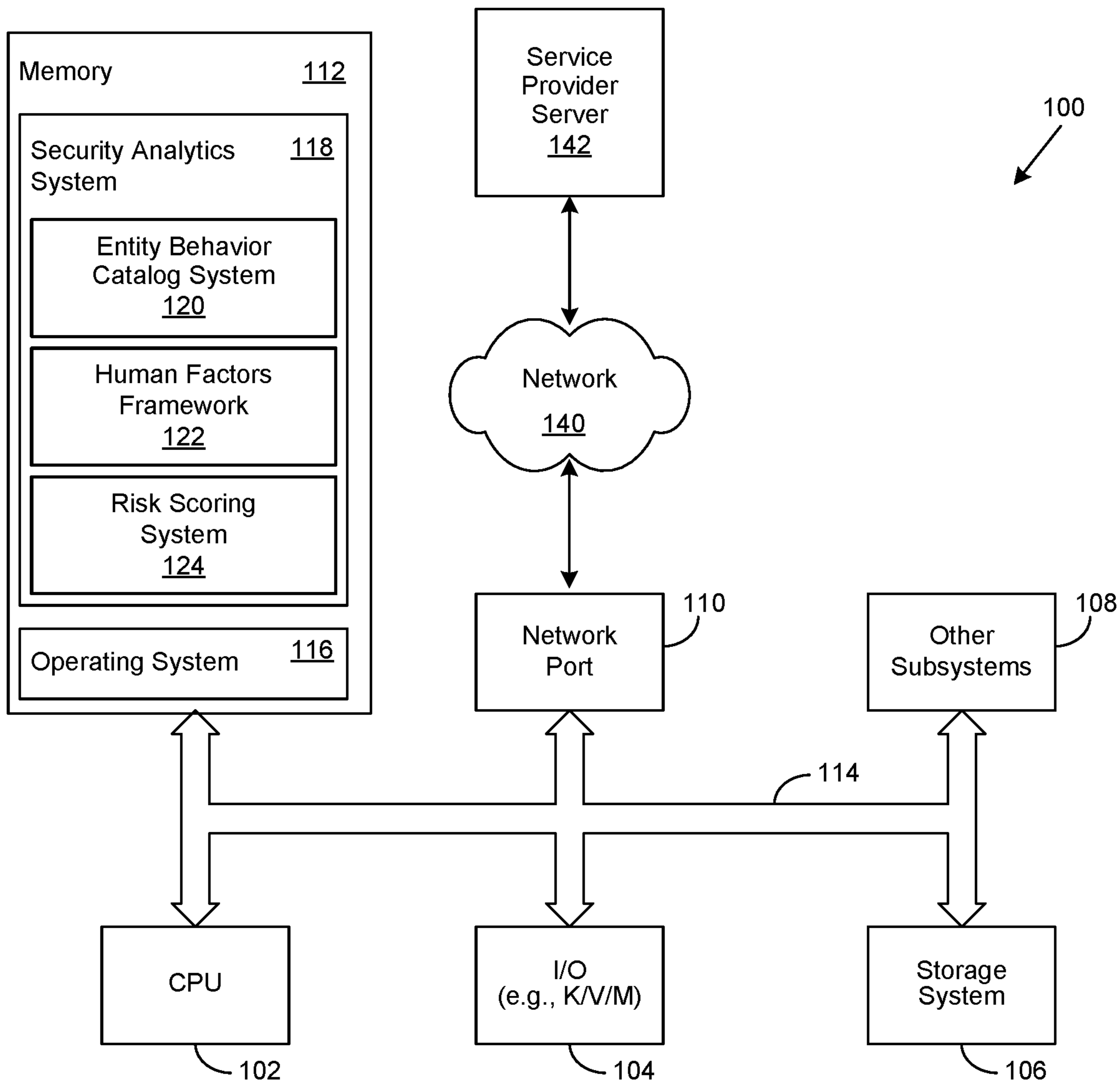

FIGURE 1

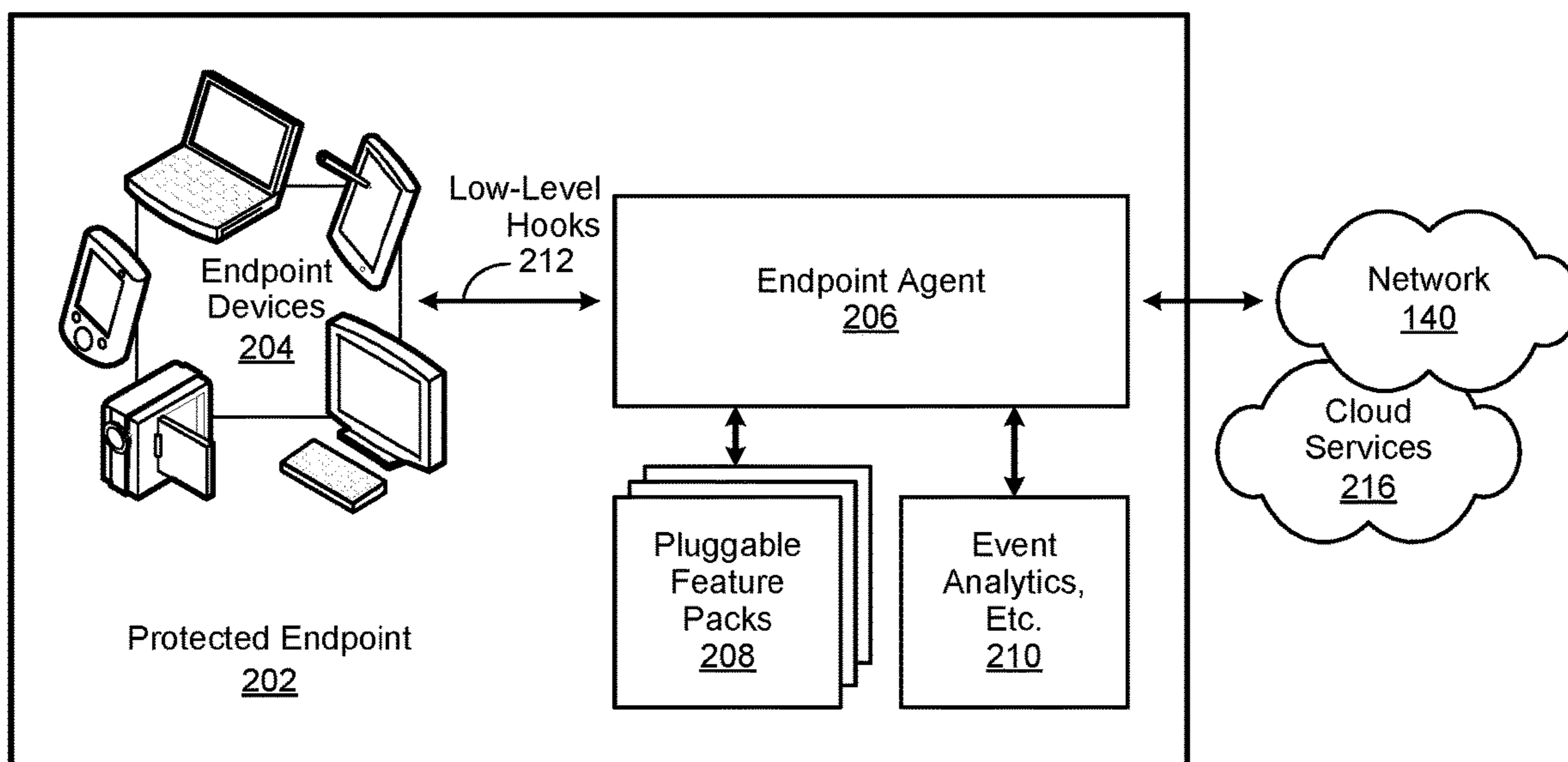

FIGURE 2

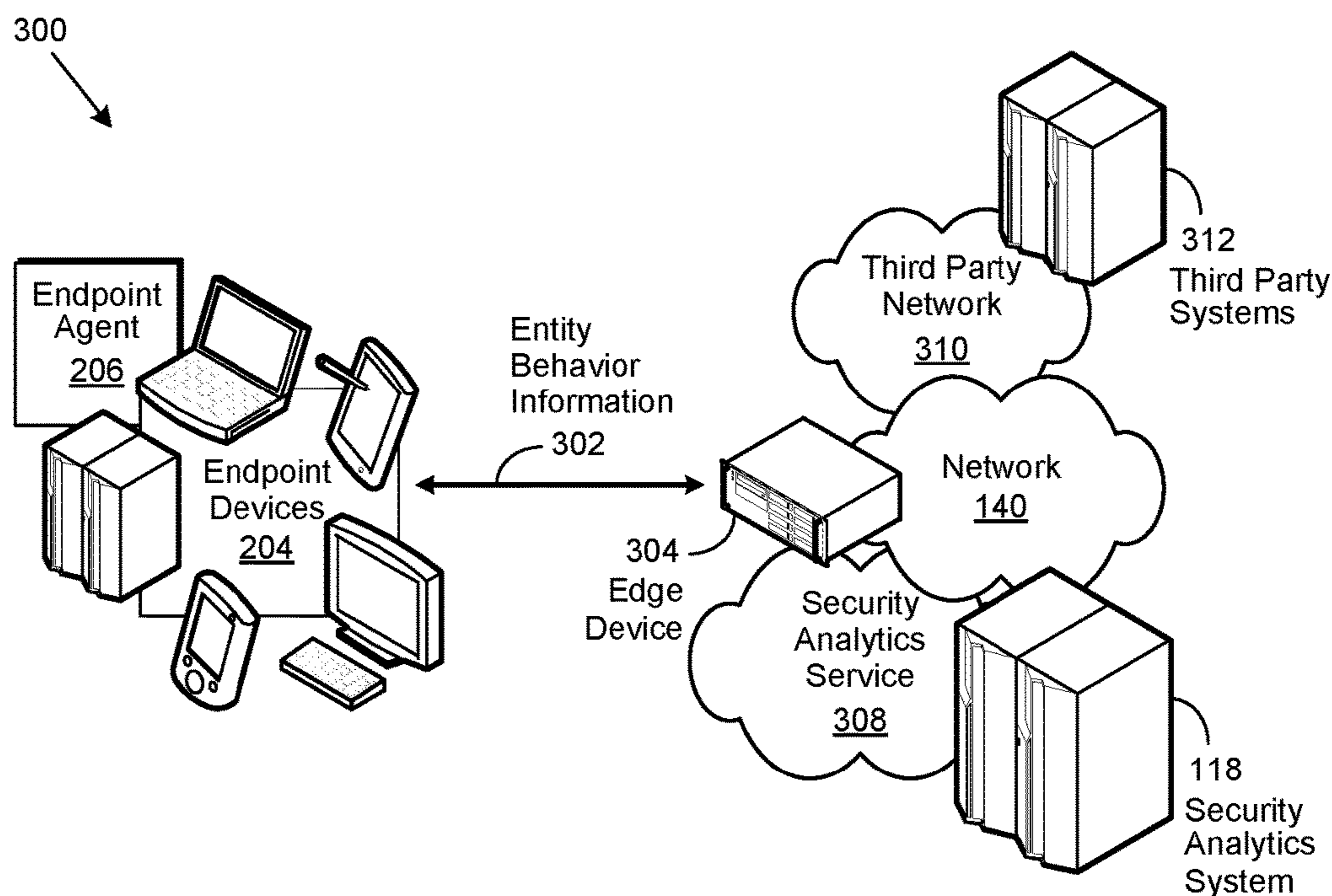

FIGURE 3

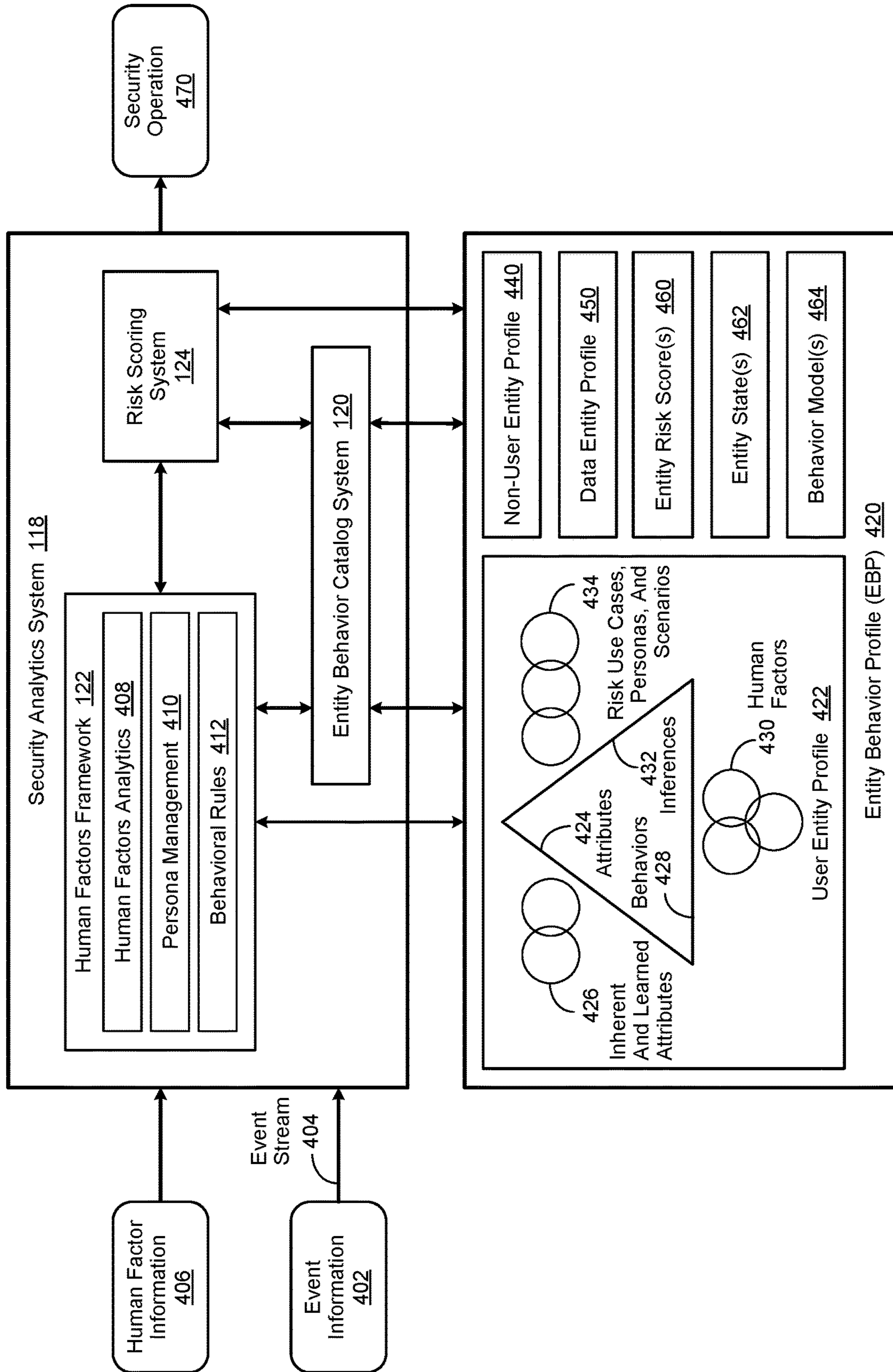

FIGURE 4

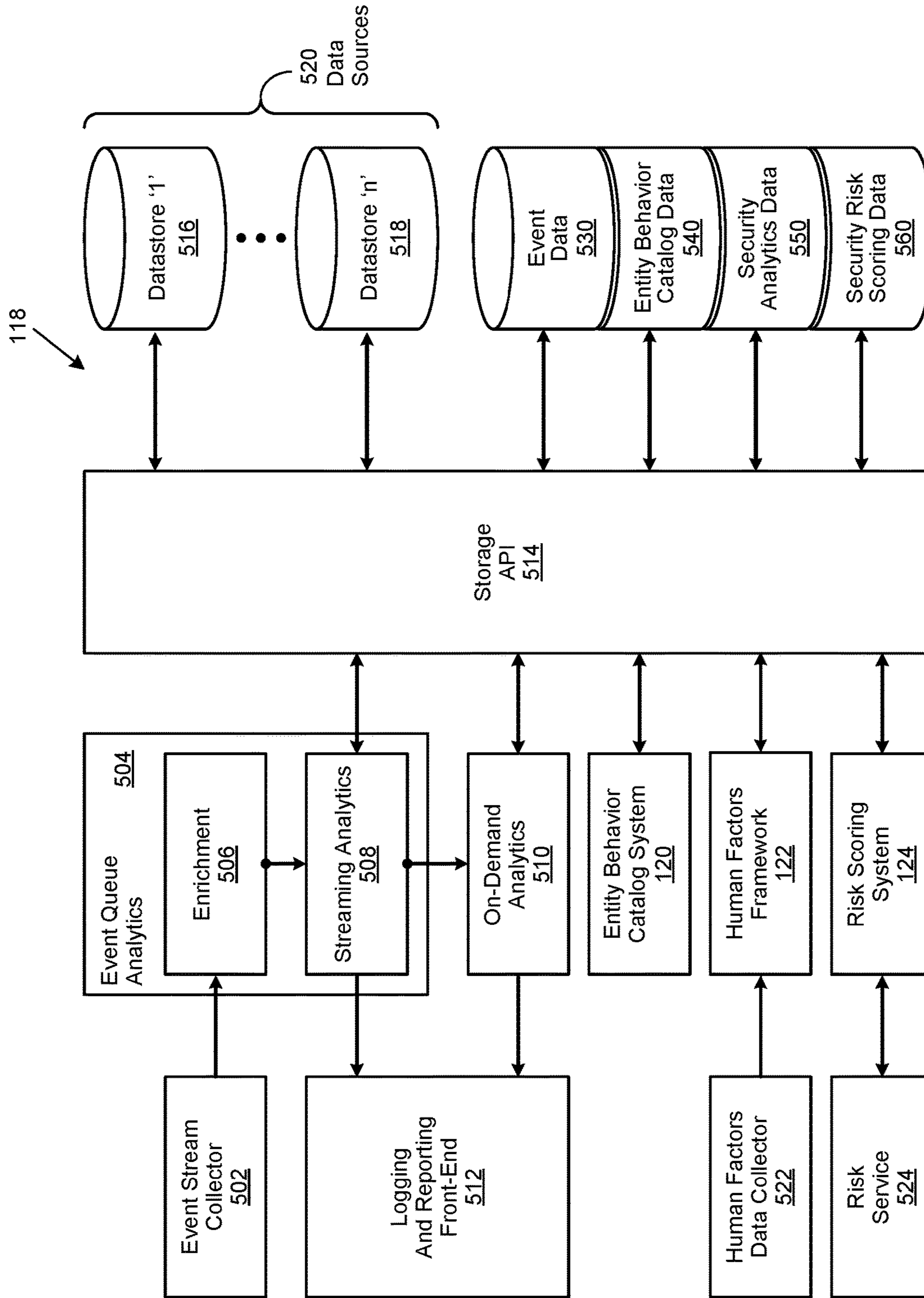

FIGURE 5

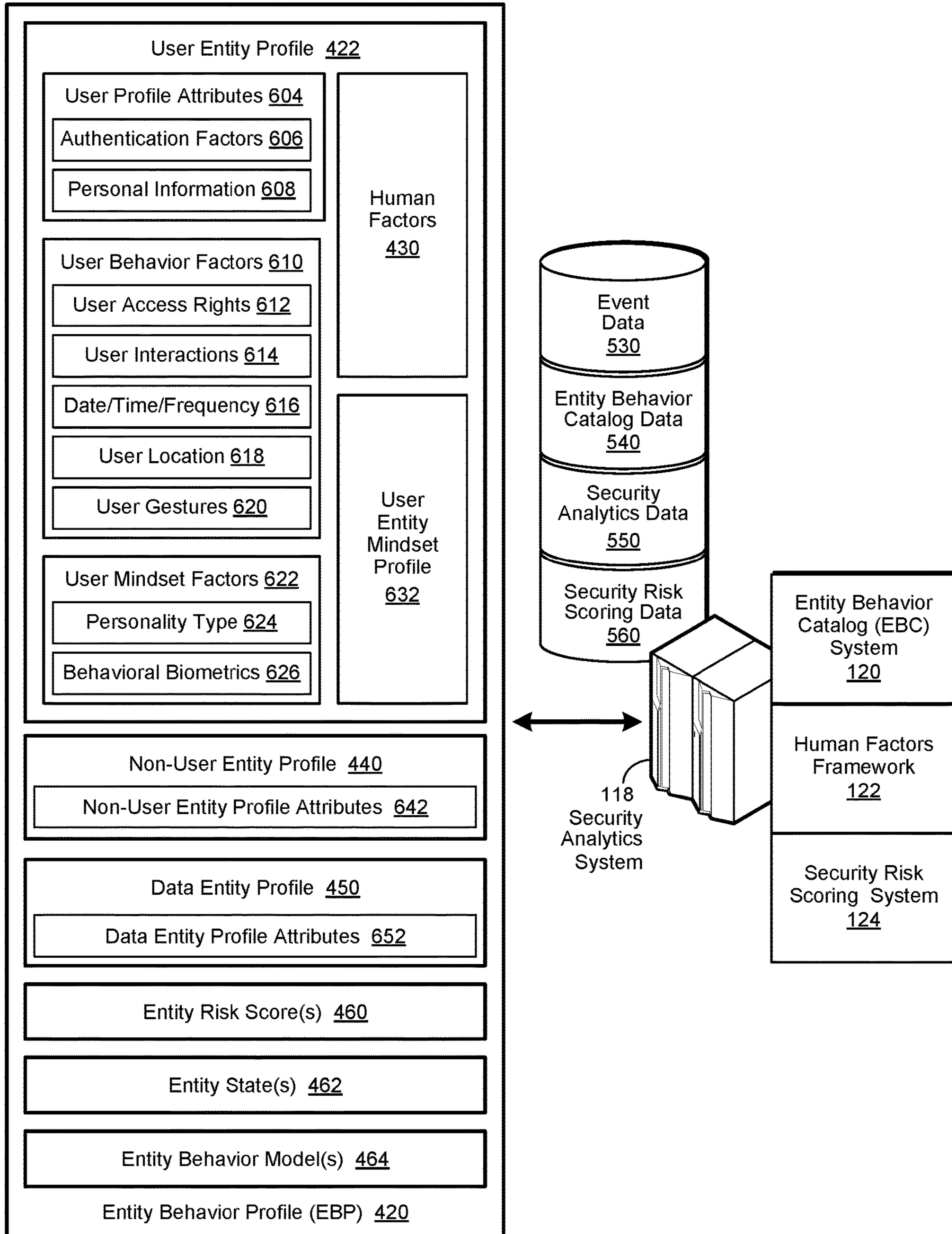

FIGURE 6

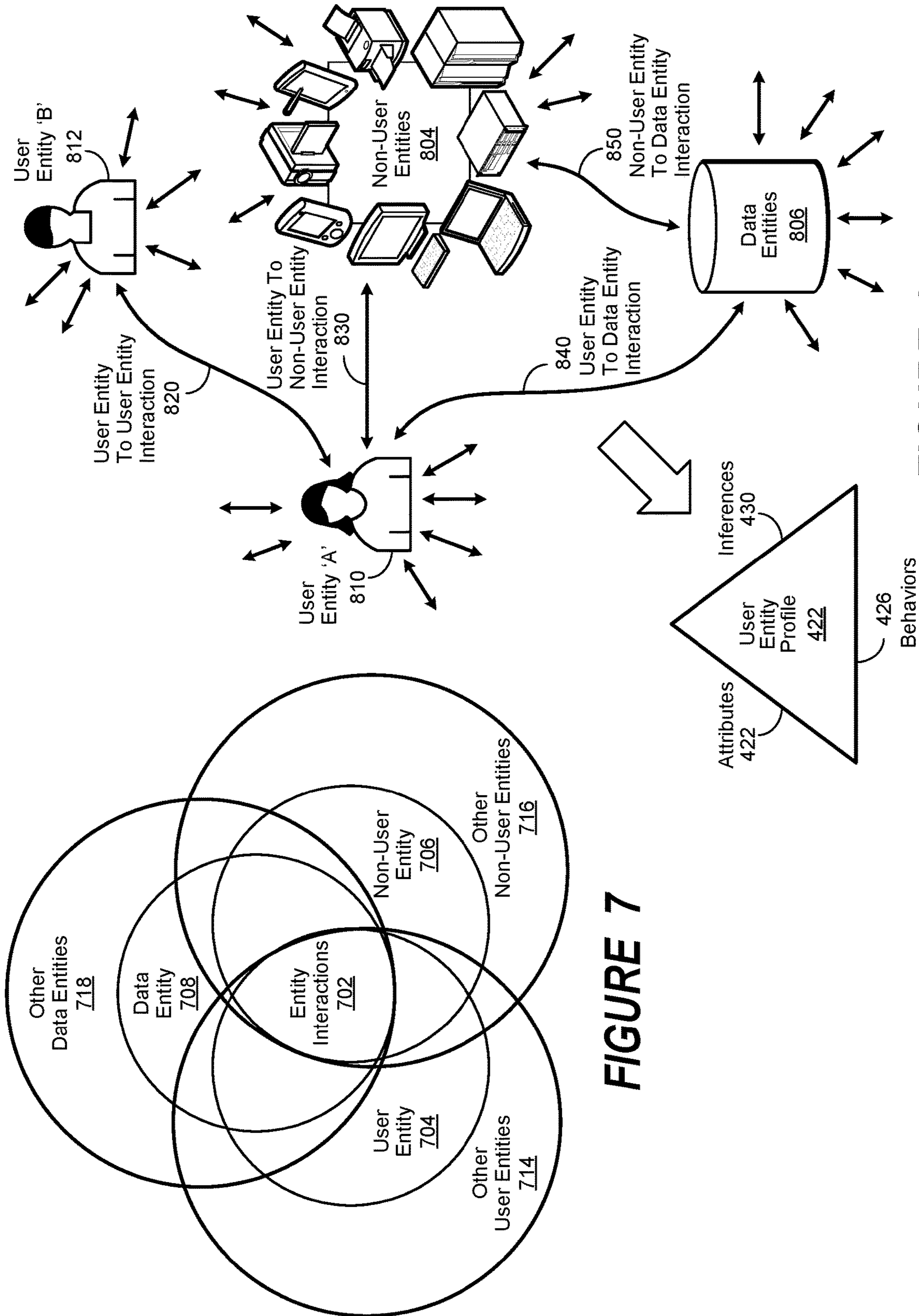

FIGURE 7

FIGURE 8

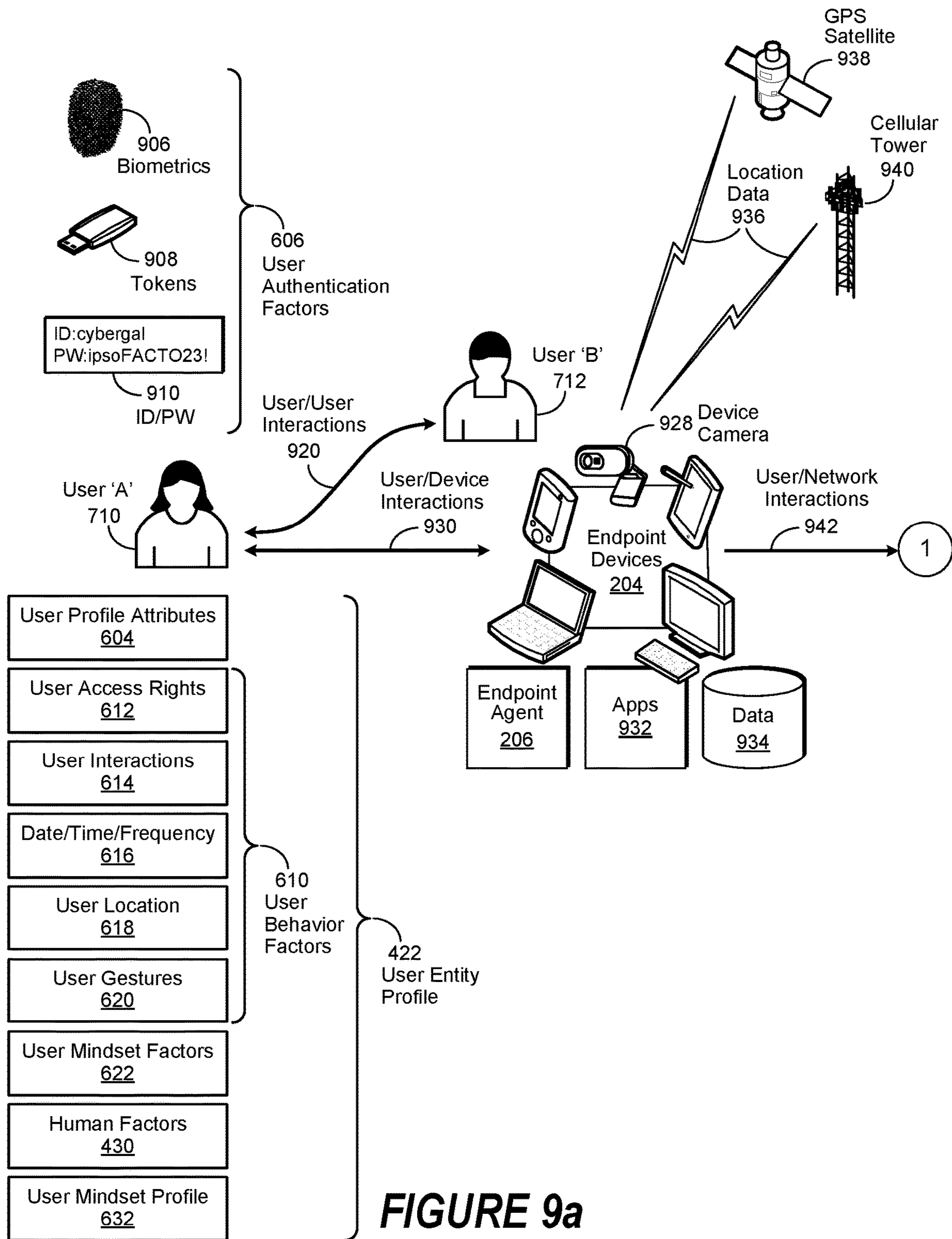

FIGURE 9a

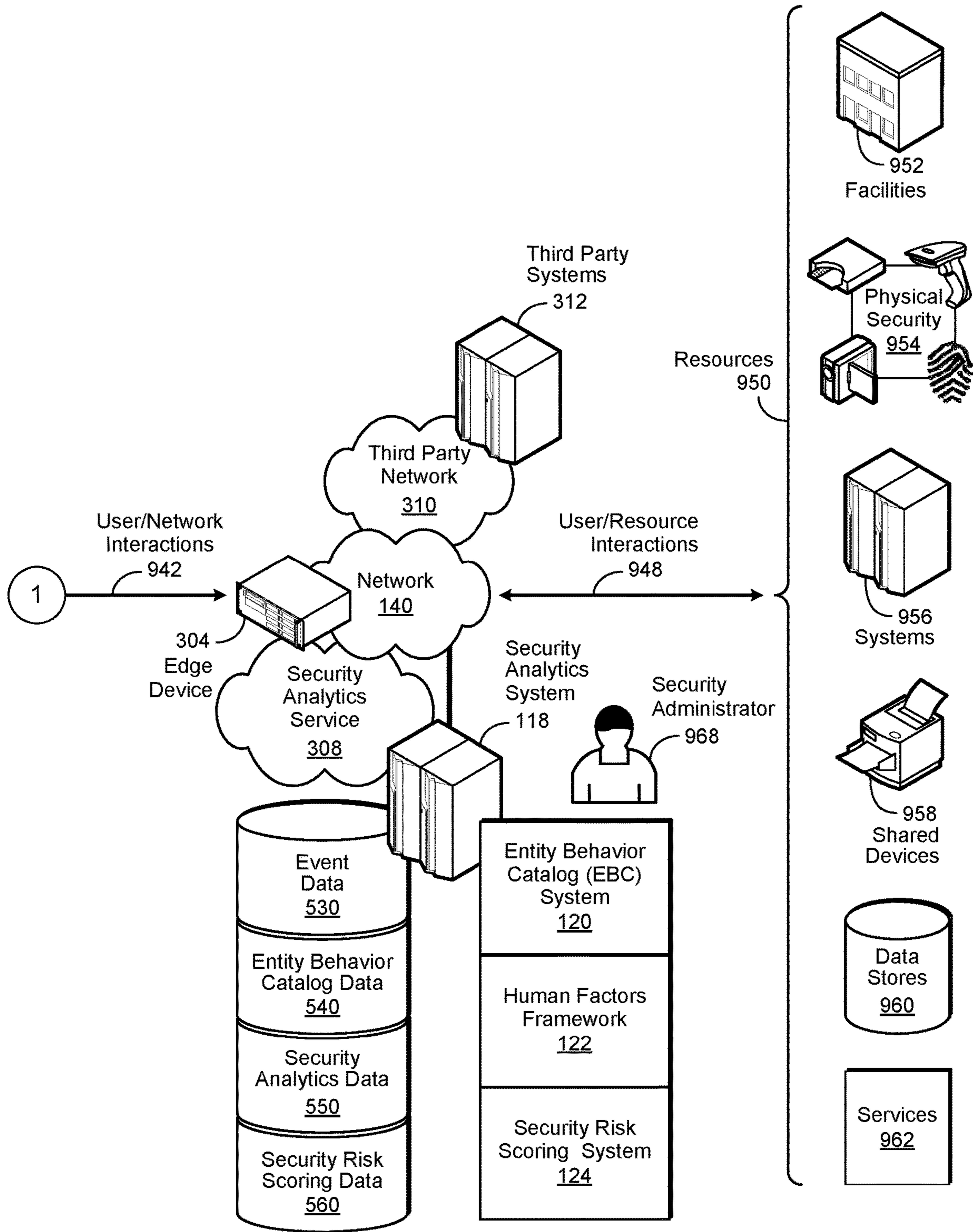

FIGURE 9b

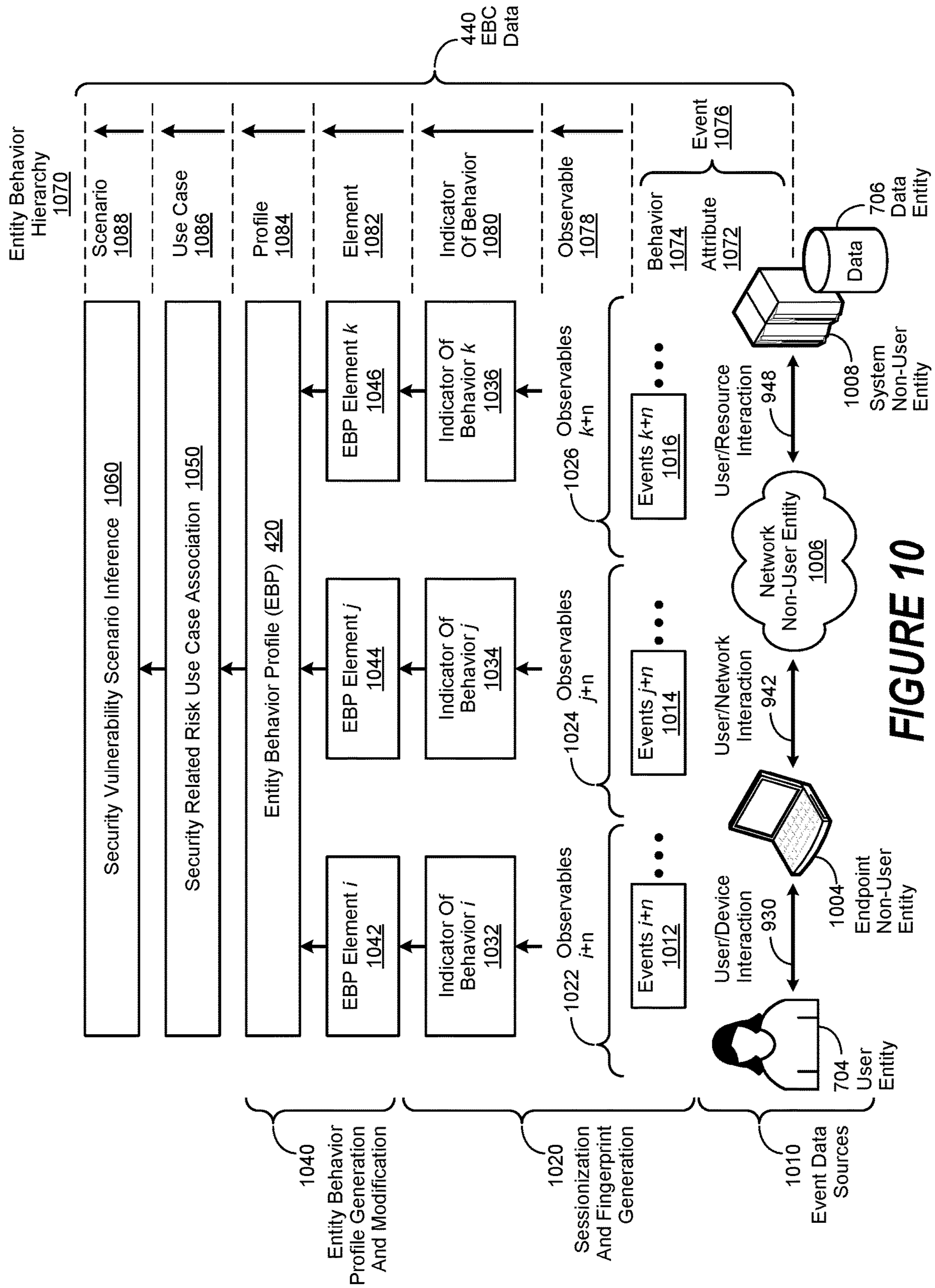

FIGURE 10

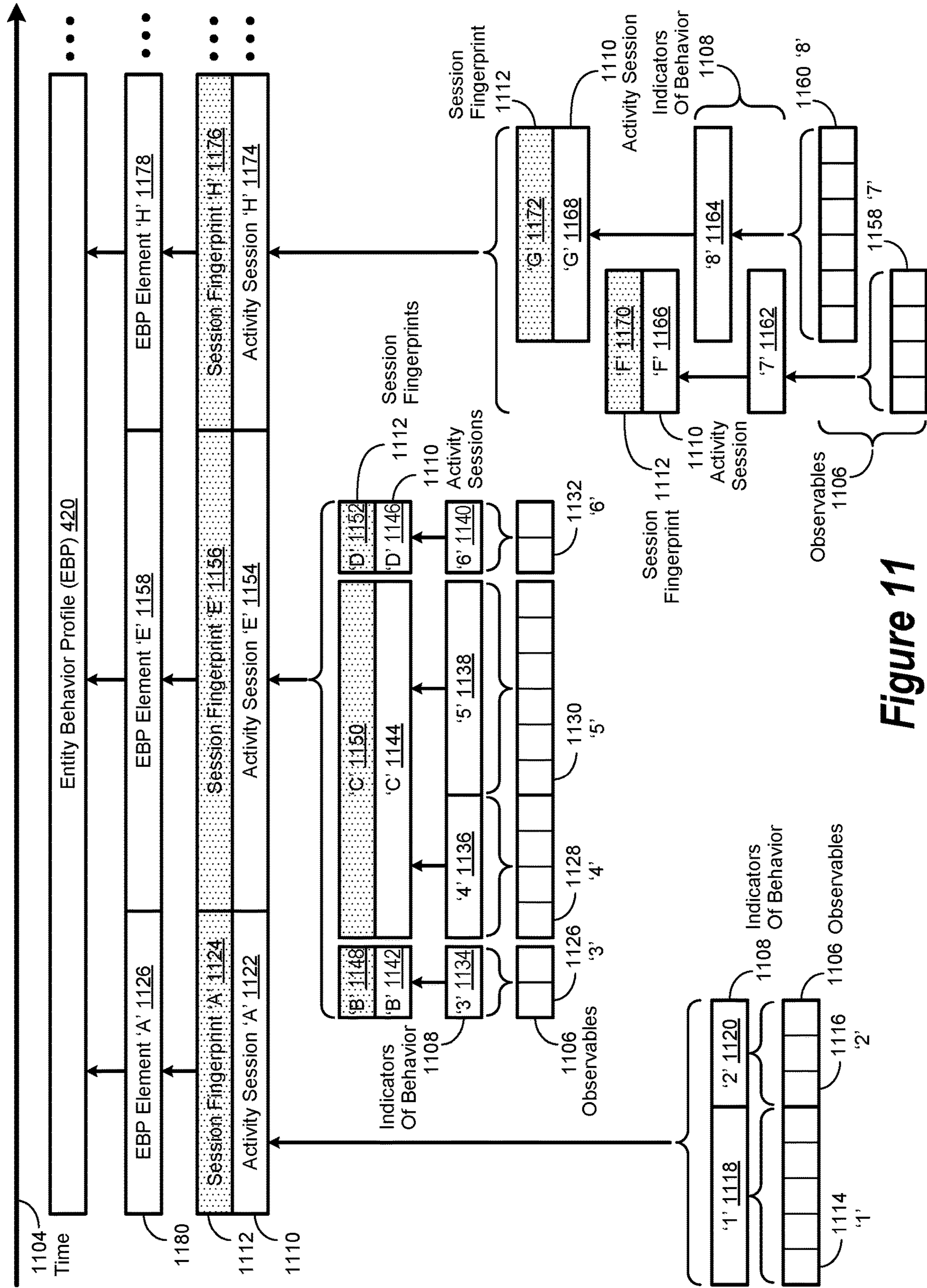

Figure 11

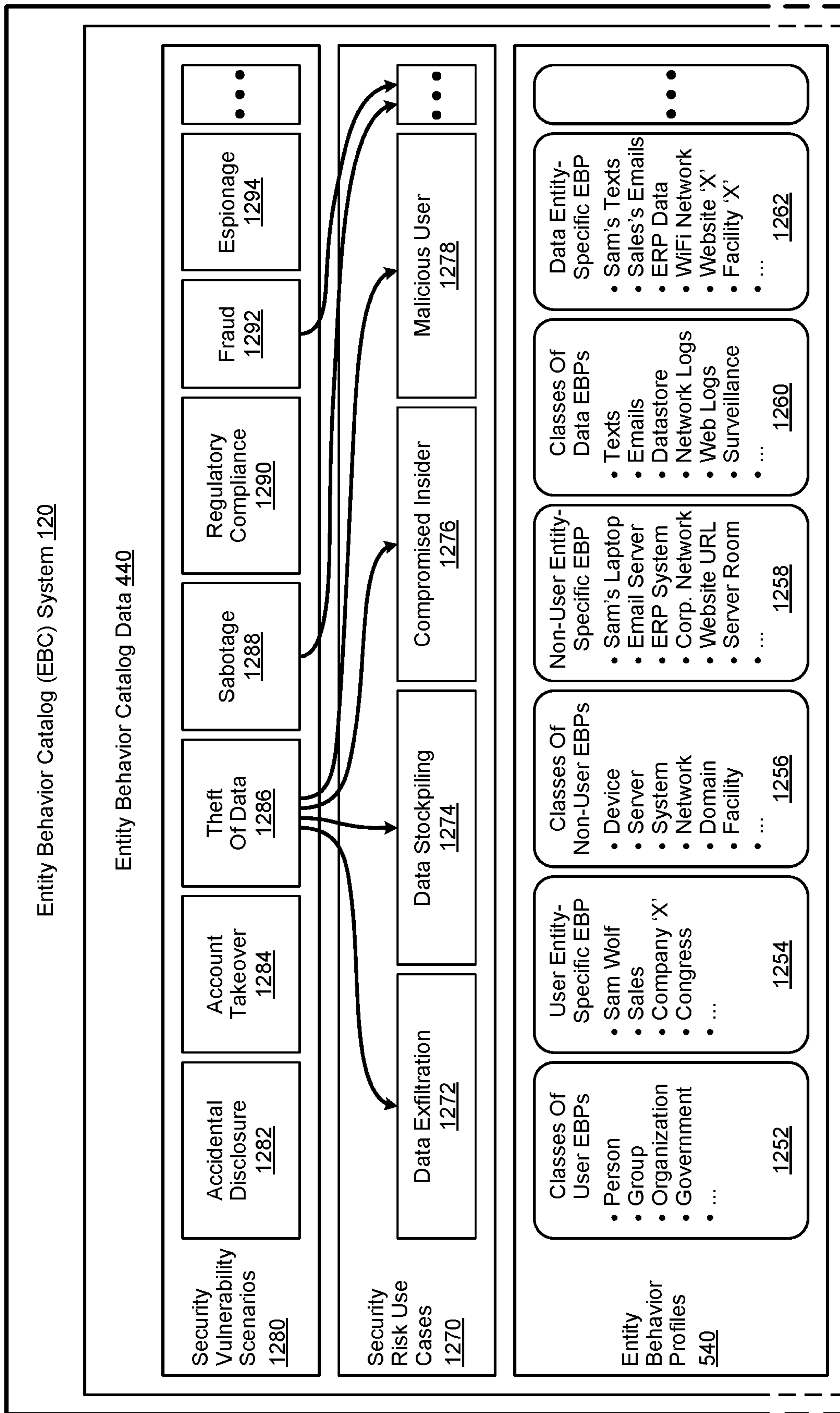

FIGURE 12a

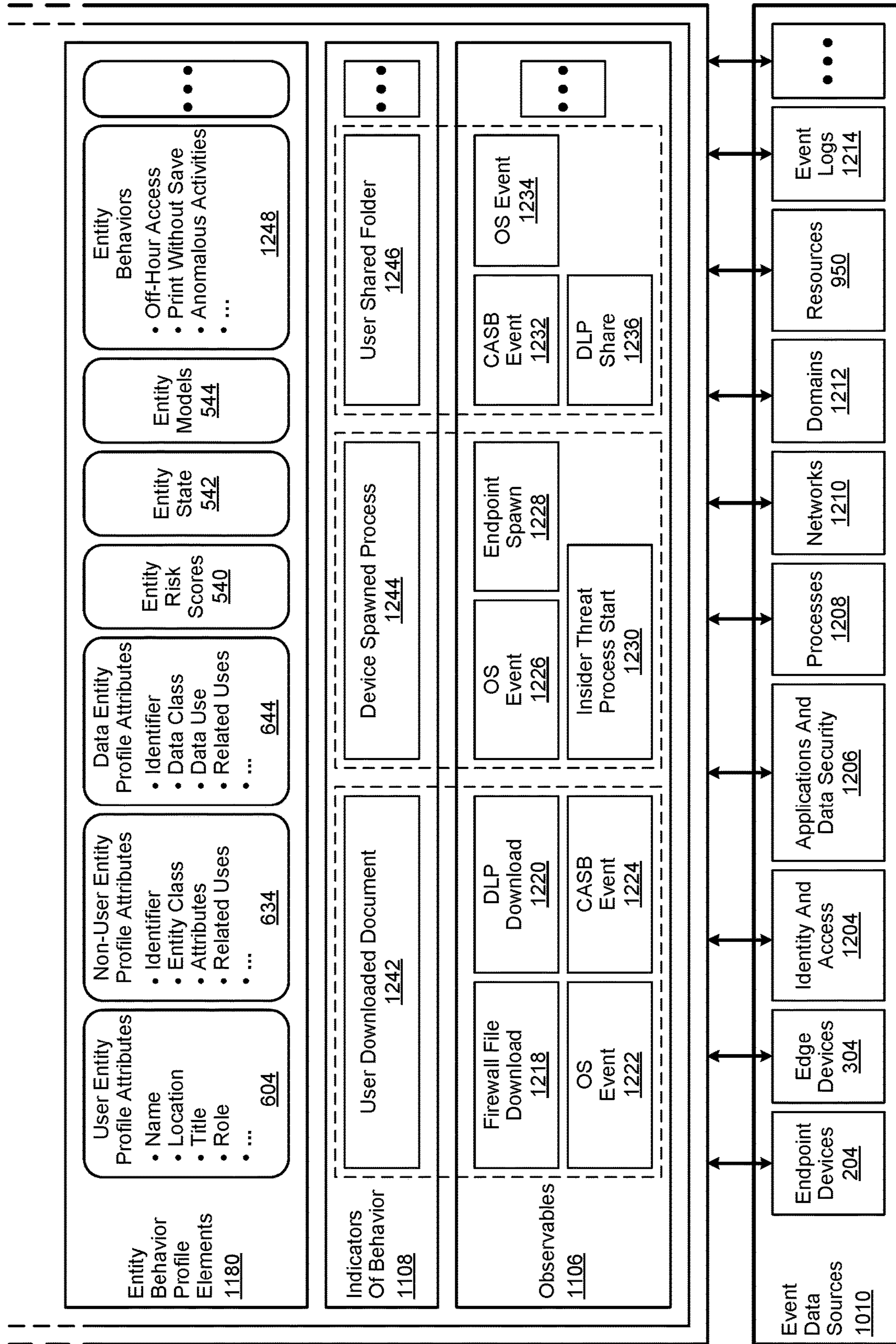

FIGURE 12b

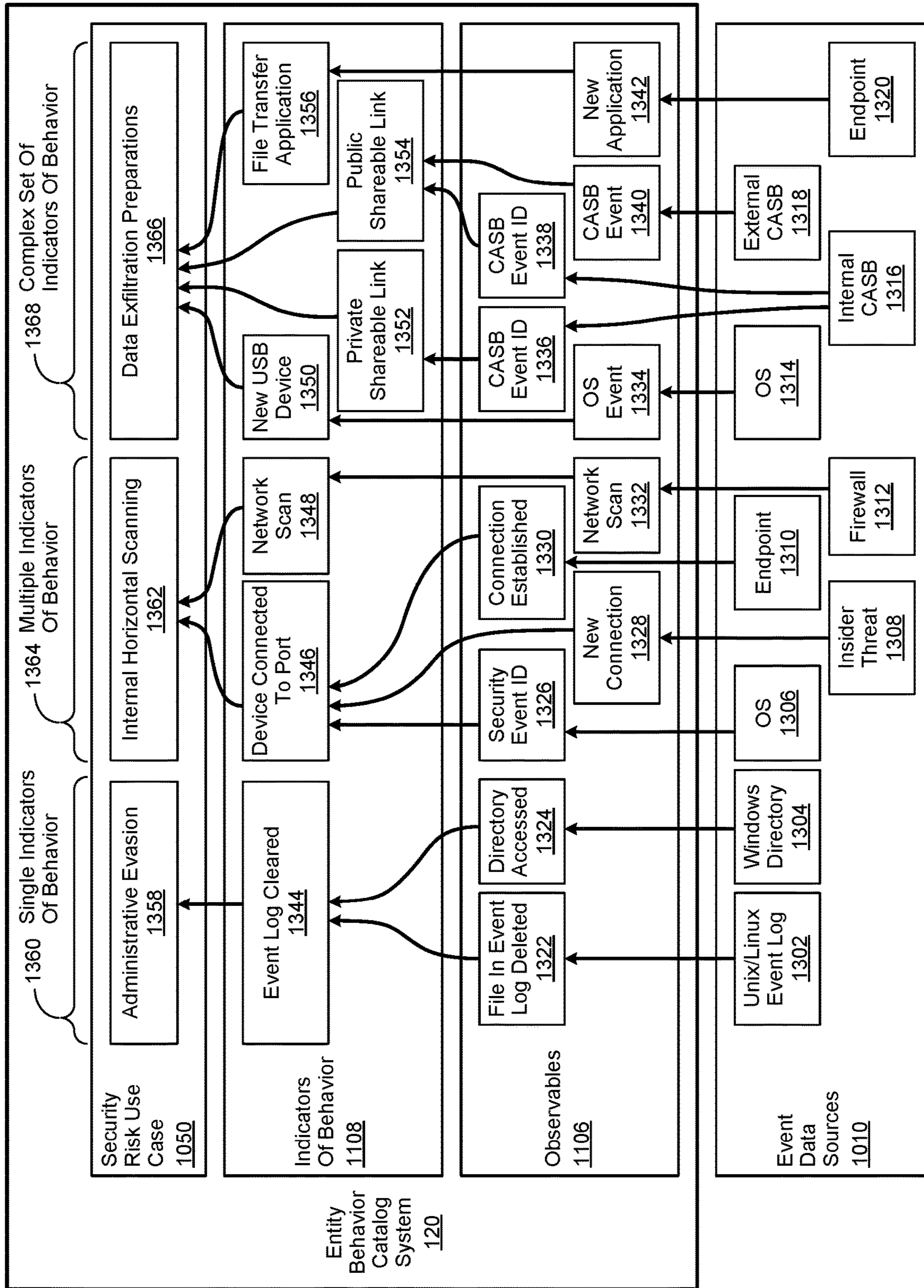

FIGURE 13

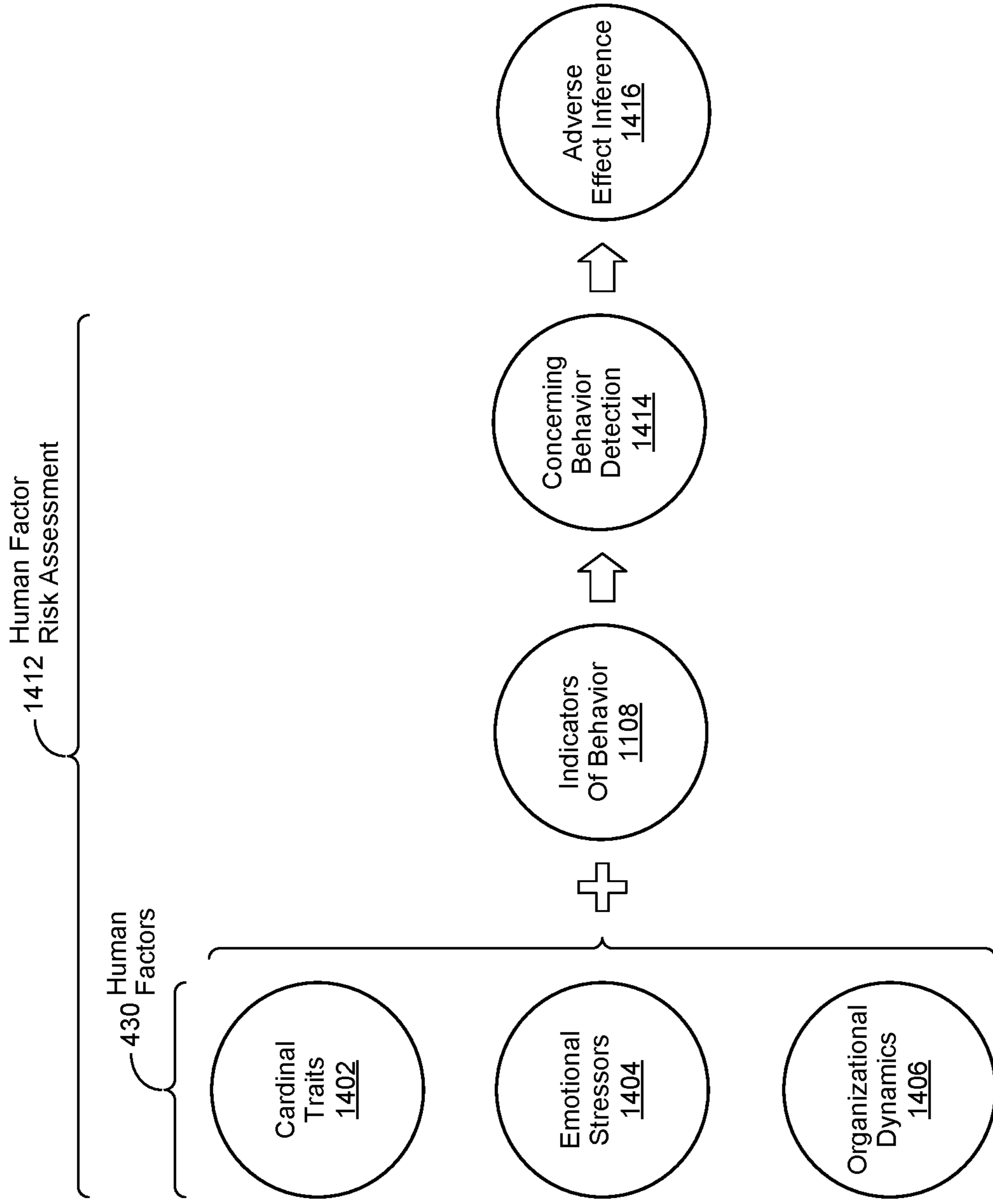

FIGURE 14

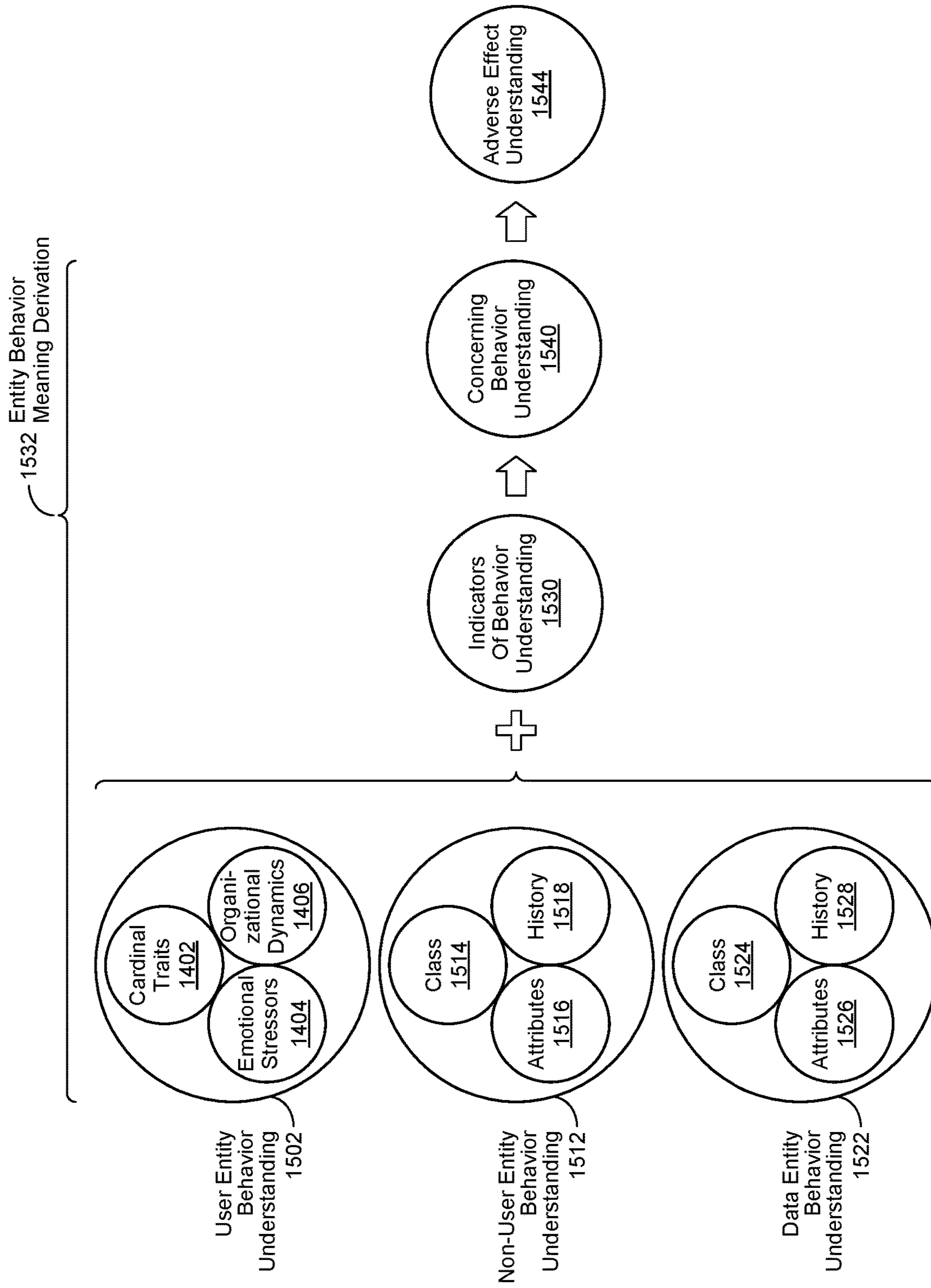

FIGURE 15

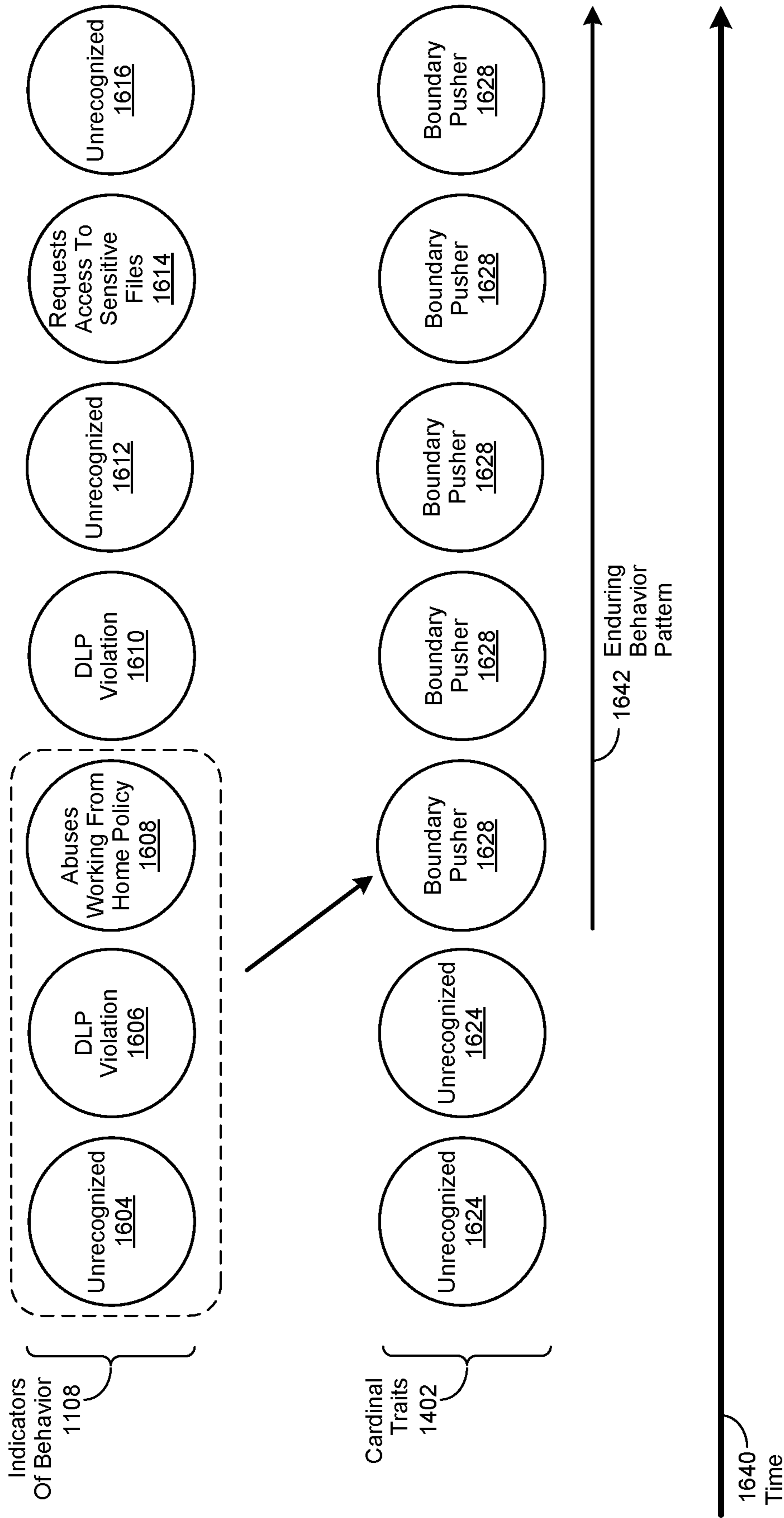

FIGURE 16

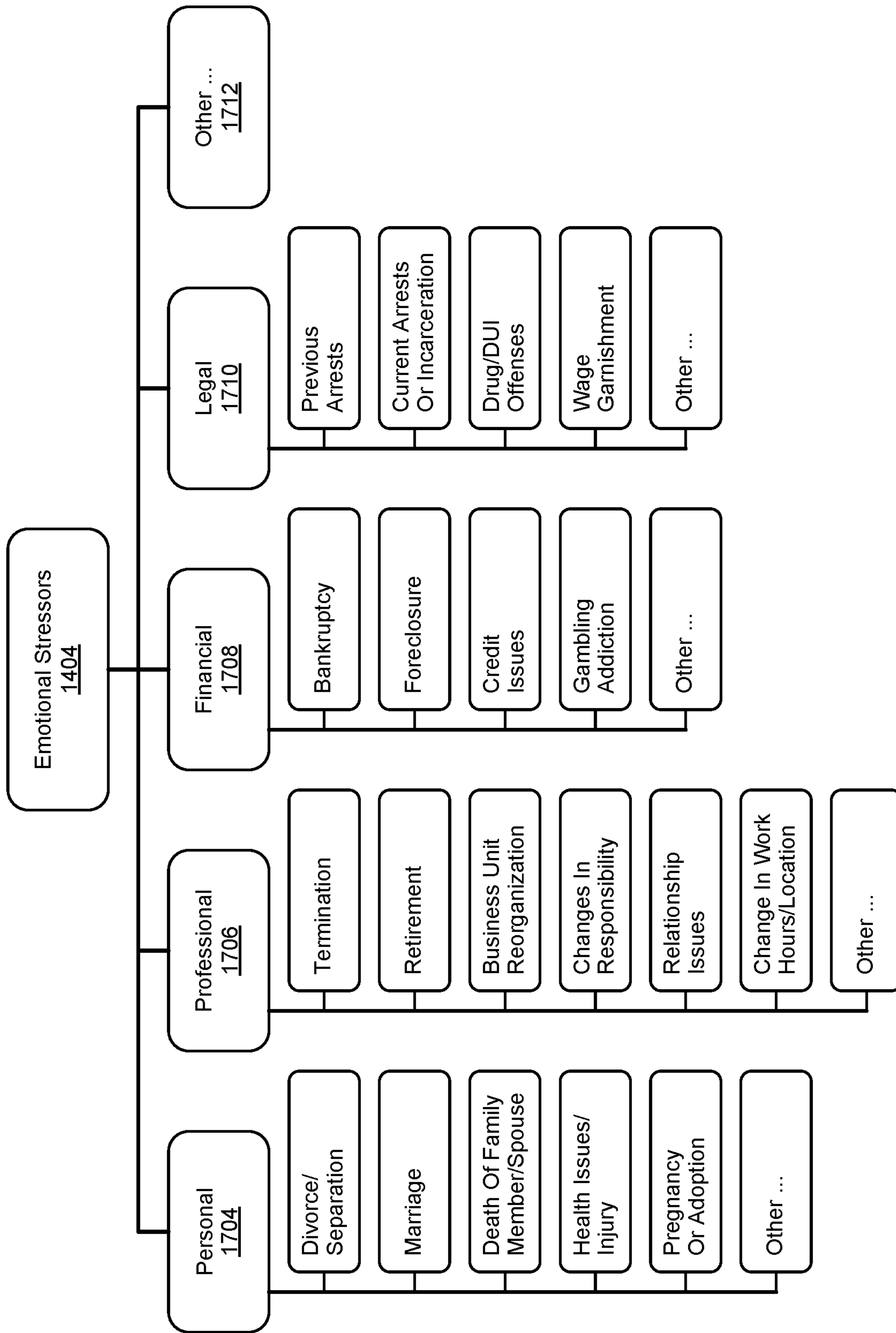

FIGURE 17

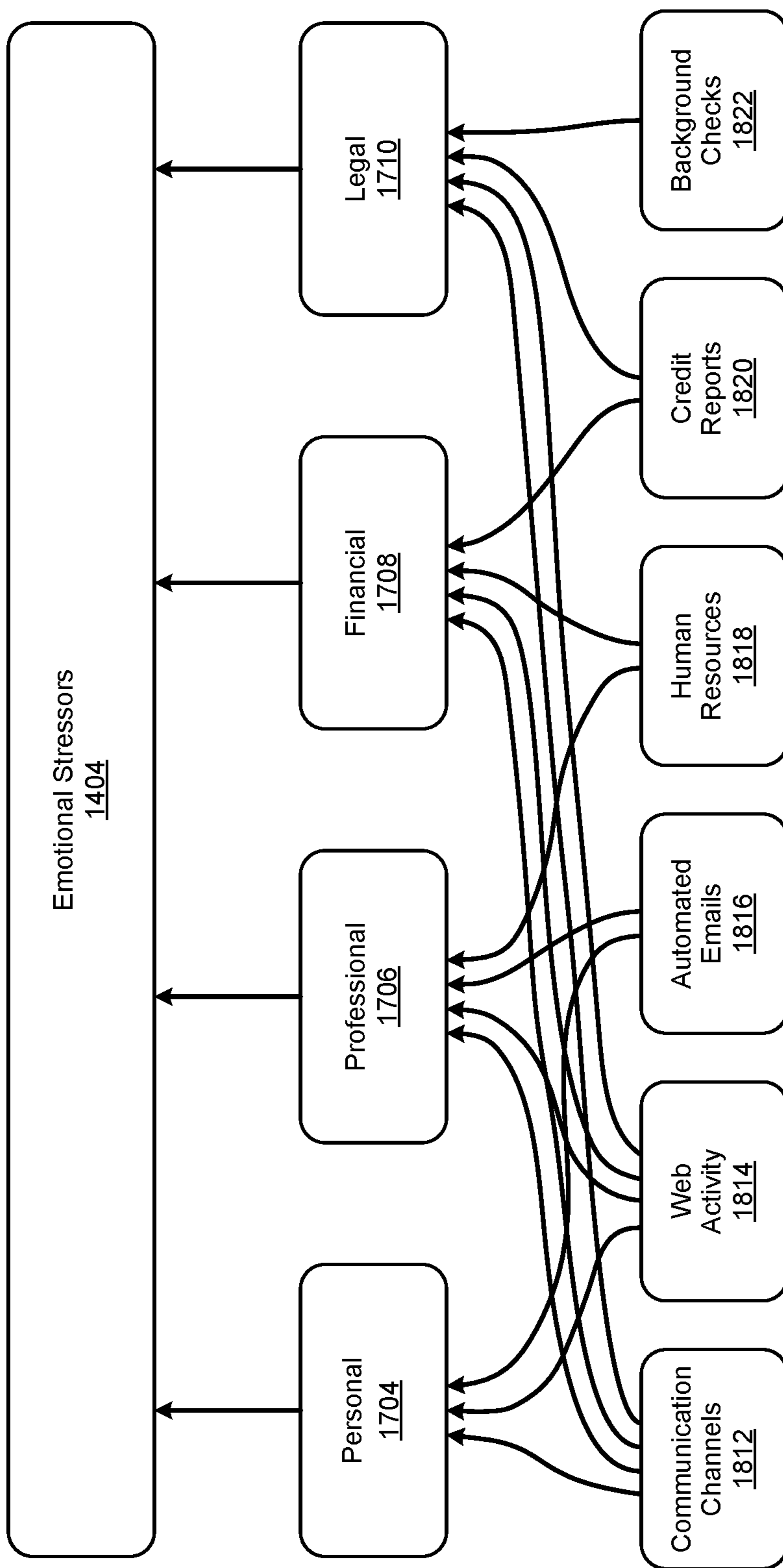

FIGURE 18

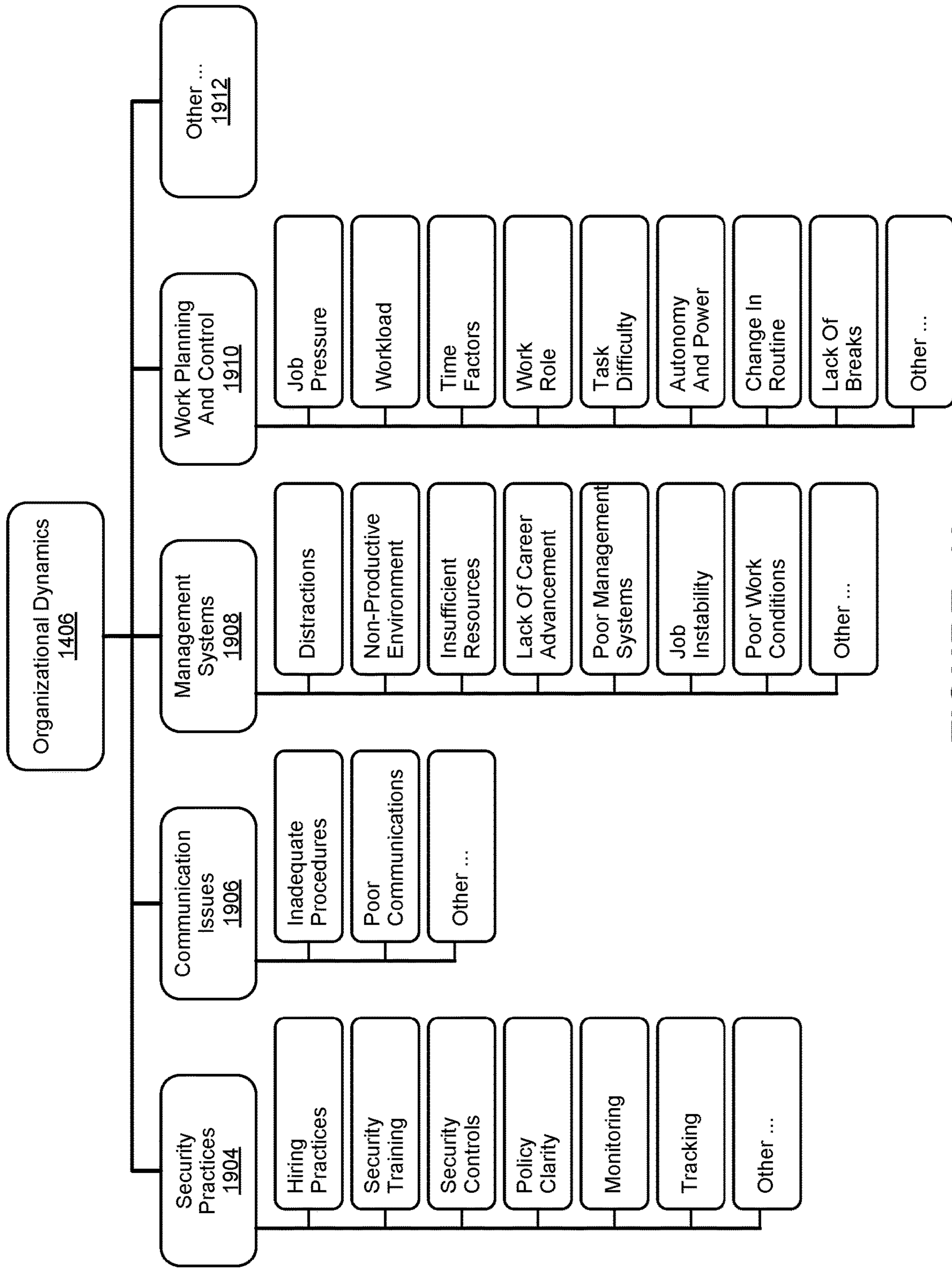

FIGURE 19

2000
↙

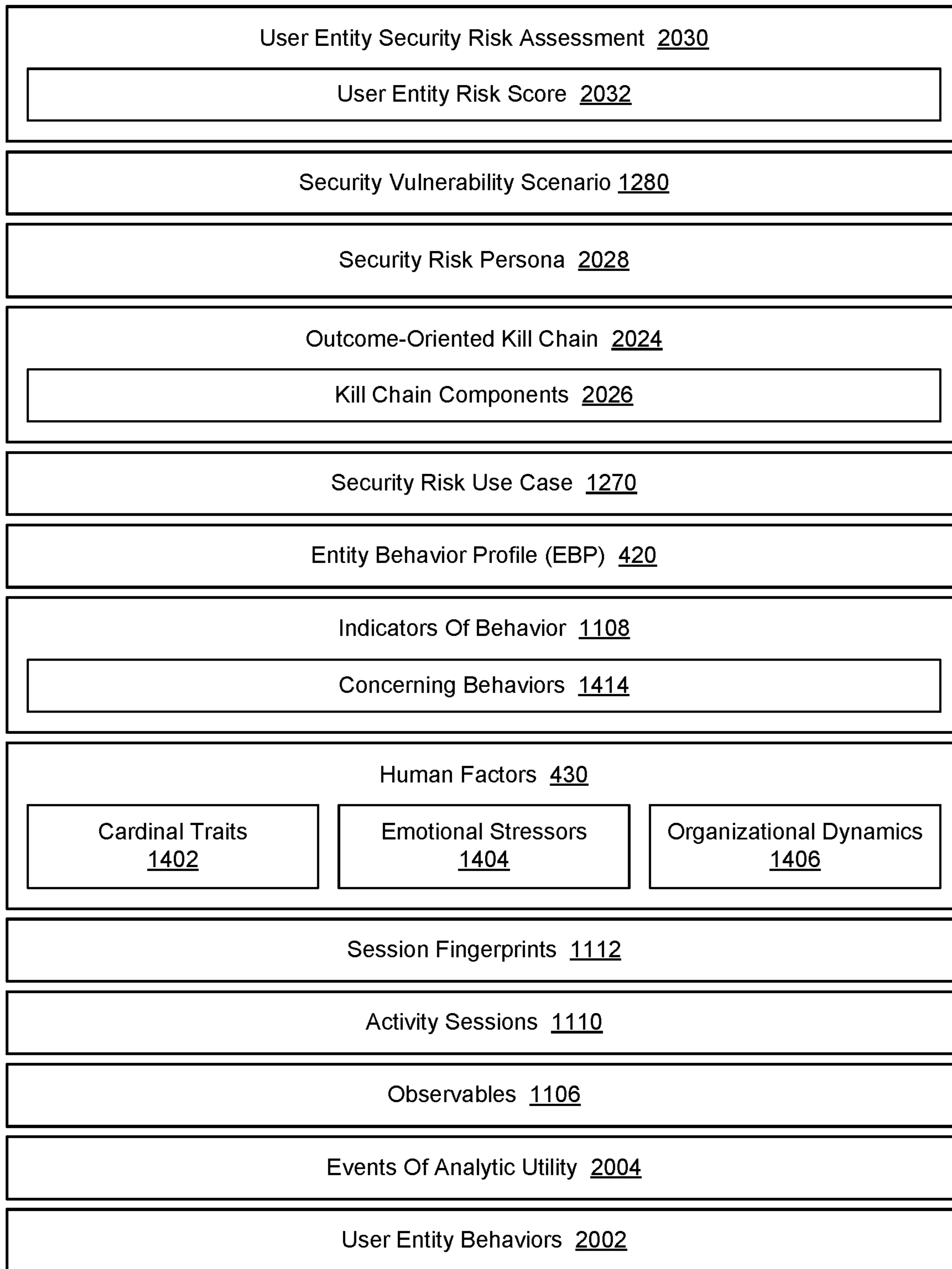

FIGURE 20

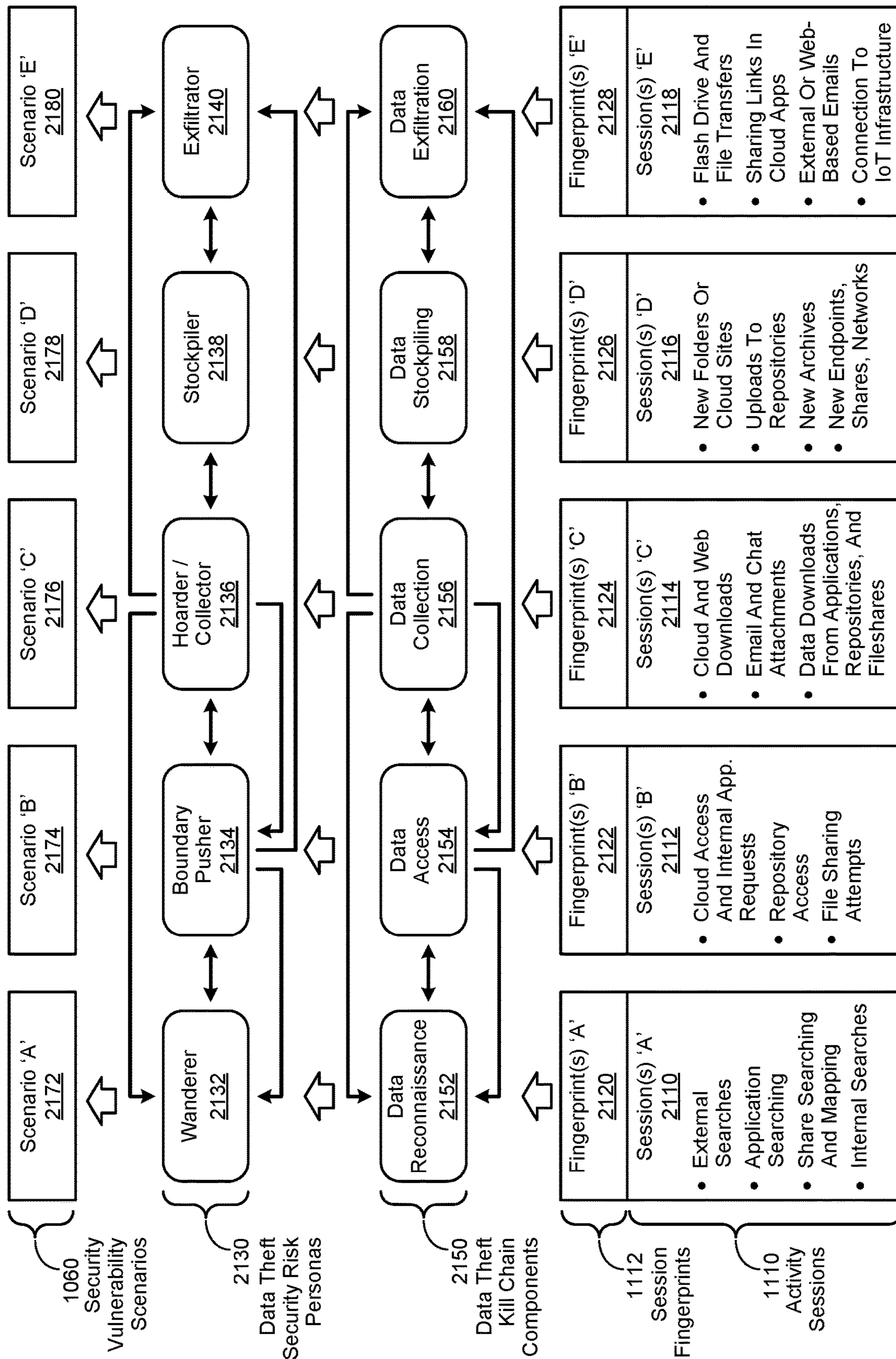

FIGURE 21

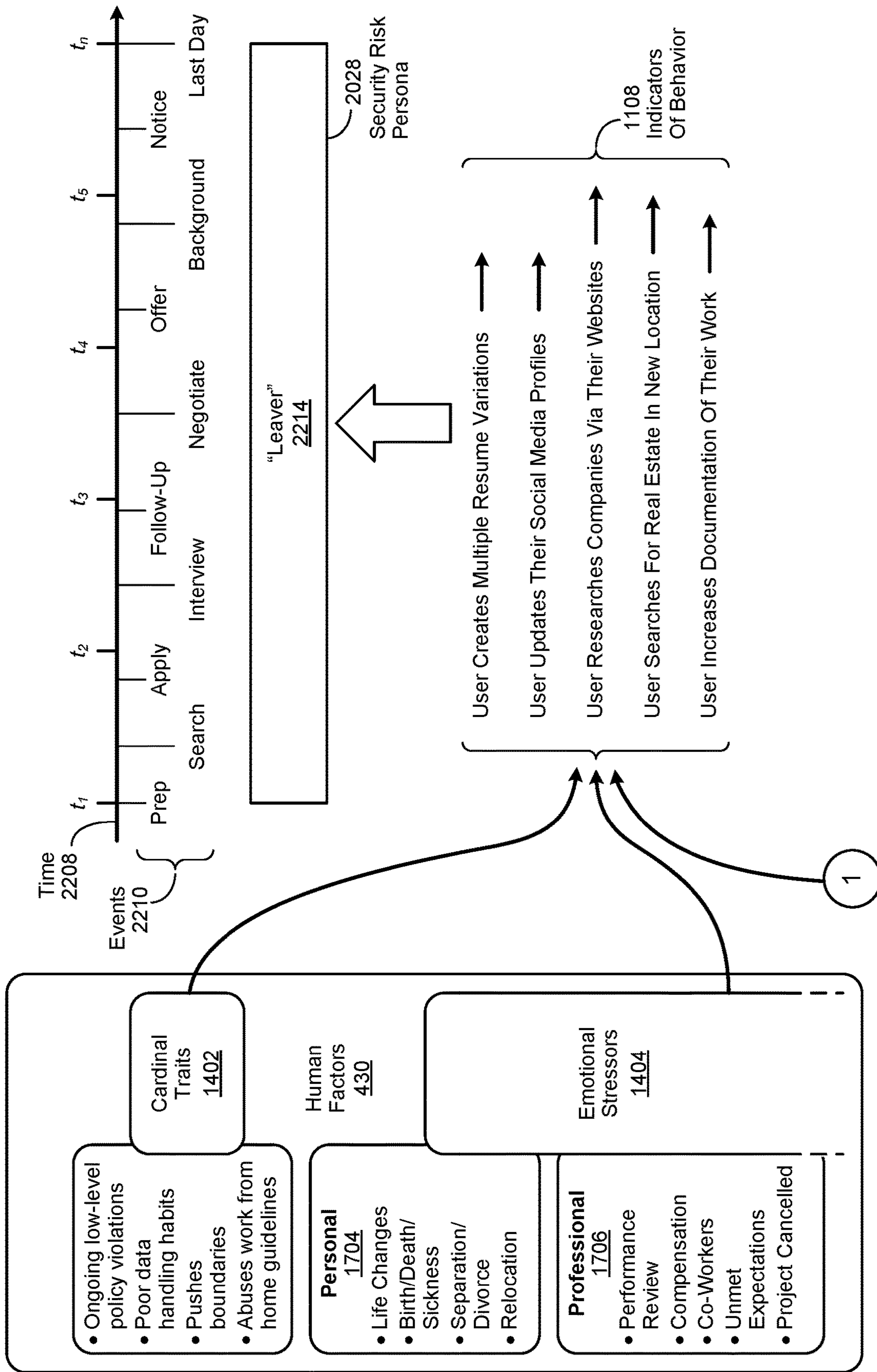

FIGURE 22a

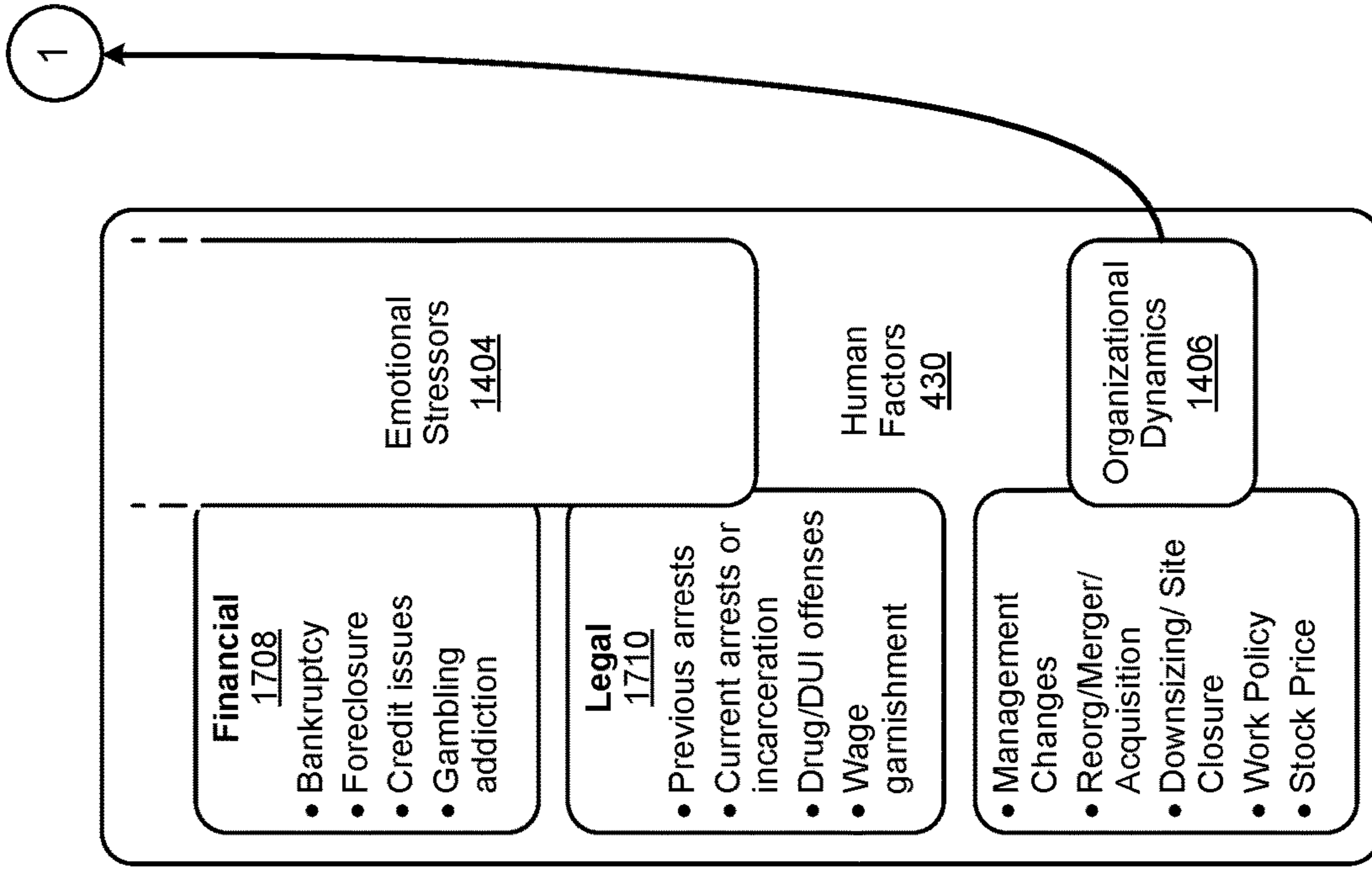

FIGURE 22b

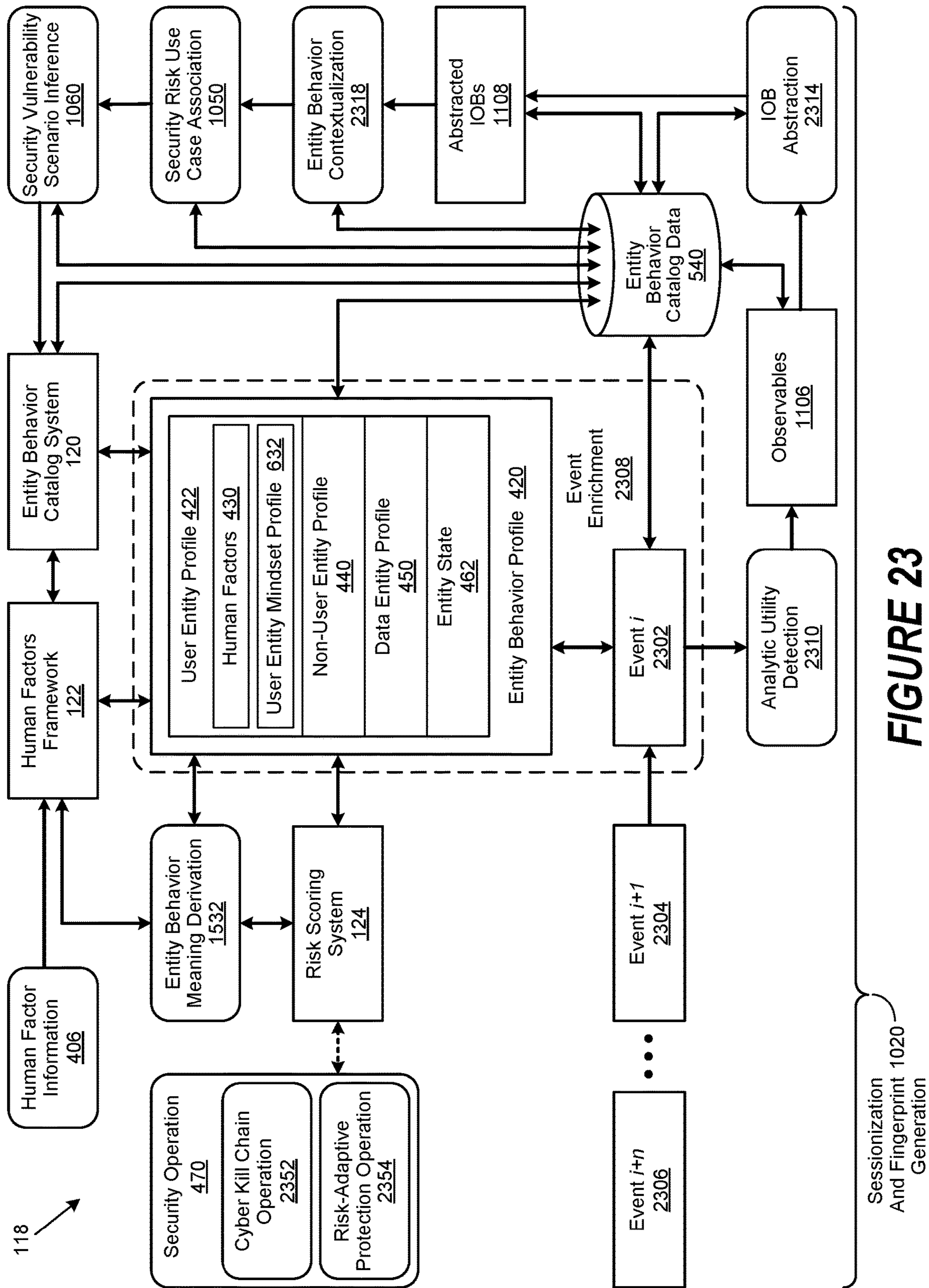

FIGURE 23

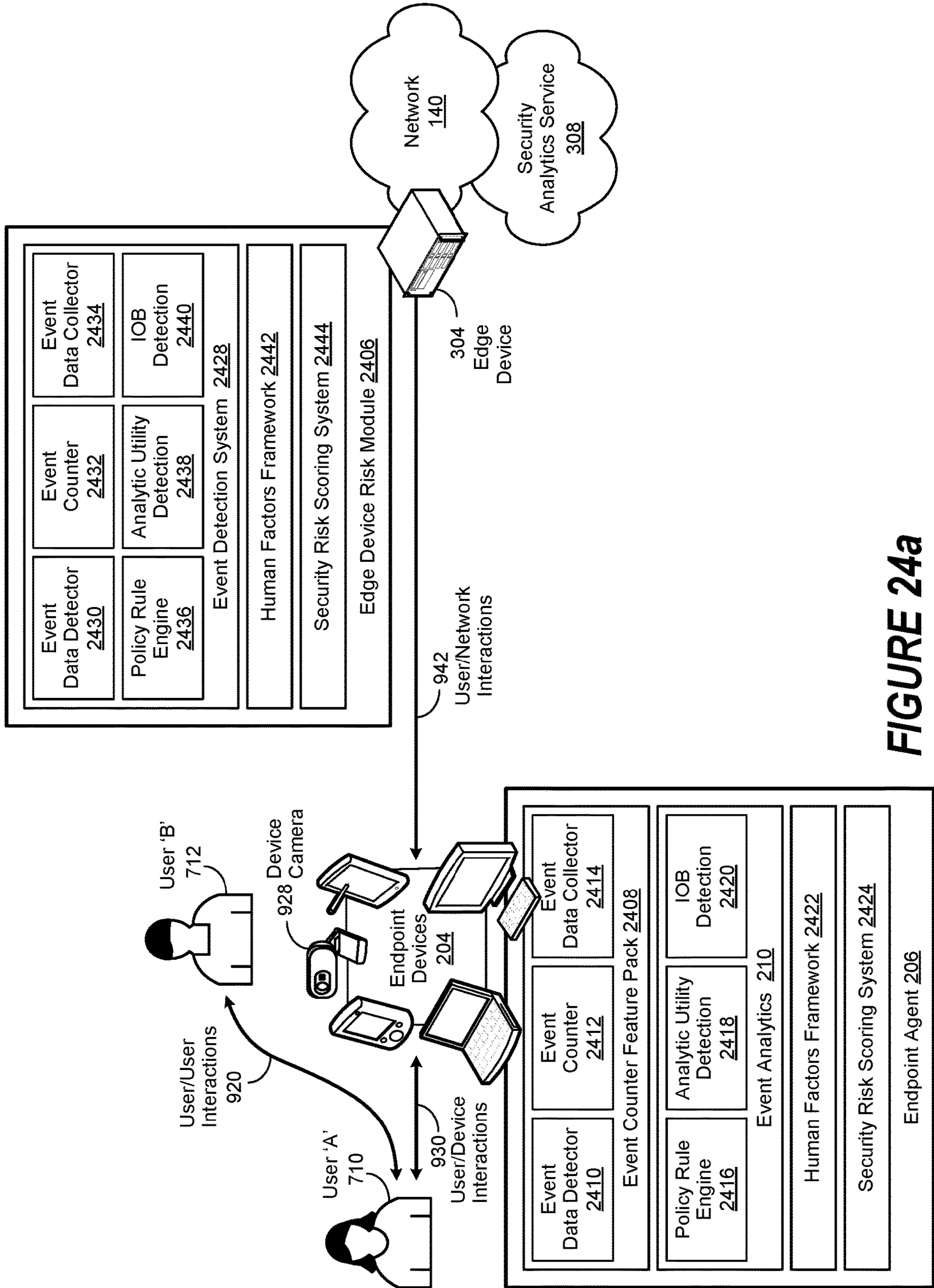

FIGURE 24a

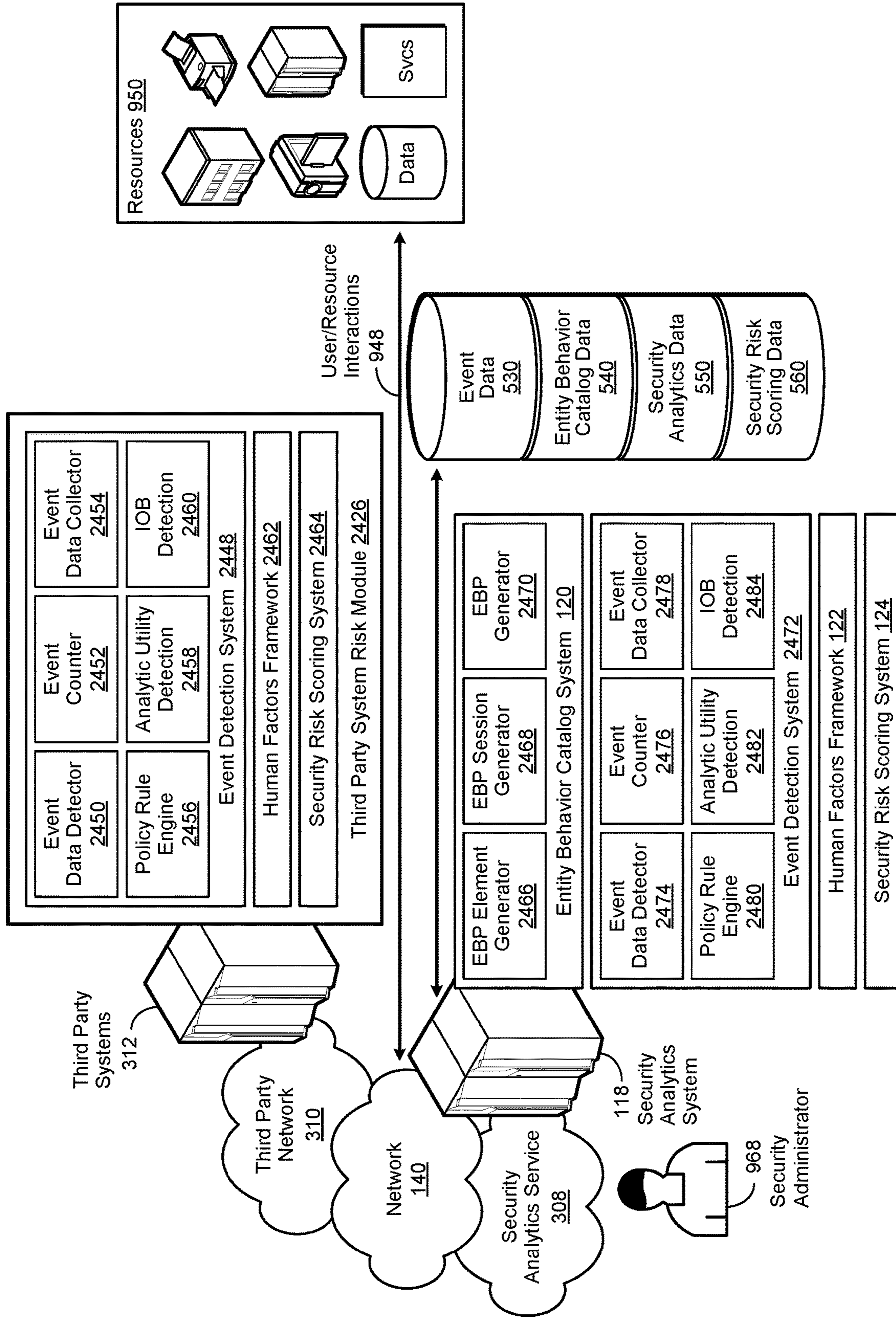

FIGURE 24b

Security Risk Persona 2508	Median Risk Score 2510	Vulnerability Scenario 1060
Wanderer	15	Data Theft
Boundary Pusher	20	Data Theft
Hoarder / Colector	35	Data Theft
Stockpiler	55	Data Theft
Exfiltrator	75	Data Theft

FIGURE 25a

Calendar Interval 2520	Security Risk Persona 2508	Median Risk Score 2510	Enduring Behavior Pattern 1642	Security Vulnerability Scenario 1060	Concerning Behavior Risk Score 2518	Human Factors 430			User Entity Risk Score 2530
						Cardinal 1402	Stressor 1404	Organizational 1406	
Jan/1	Boundary Pusher	0	Undetermined	Data Theft	22				22
Jan/2	Boundary Pusher	0	Undetermined	Data Theft	21				21
Feb/1	Boundary Pusher	0	Undetermined	Data Theft	22				22
Feb/2	Boundary Pusher	0	Undetermined	Data Theft	24		2		26
Mar/1	Boundary Pusher	20	Boundary Pusher	Data Theft	15		2		22
Mar/2	Boundary Pusher	20	Boundary Pusher	Data Theft	19		2		22
Apr/1	Boundary Pusher	20	Boundary Pusher	Data Theft	22		2		24
Apr/2	Boundary Pusher	20	Boundary Pusher	Data Theft	21		2		23
May/1	Boundary Pusher	20	Boundary Pusher	Data Theft	23		2	5	30
May/2	Boundary Pusher	20	Boundary Pusher	Data Theft	22		2	5	29
Jun/1	Undetermined	20	Undetermined	Undetermined	0		2	5	27
Jun/2	Wanderer	20	Wanderer	Data Theft	17		2	5	27
Jul/1	Boundary Pusher	20	Boundary Pusher	Data Theft	20		2	5	27
Jul/2	Hoarder/Collector	20	Hoarder/Collector	Data Theft	32	10	2	5	49
Aug/1	Boundary Pusher	20	Boundary Pusher	Data Theft	23		2	5	30
Aug/2	Boundary Pusher	20	Boundary Pusher	Data Theft	26		2	5	33
Sep/1	Hoarder/Collector	20	Hoarder/Collector	Data Theft	33	10	2	5	50
Sep/2	Stockpiler	20	Stockpiler	Data Theft	56	20	2		78

FIGURE 25b

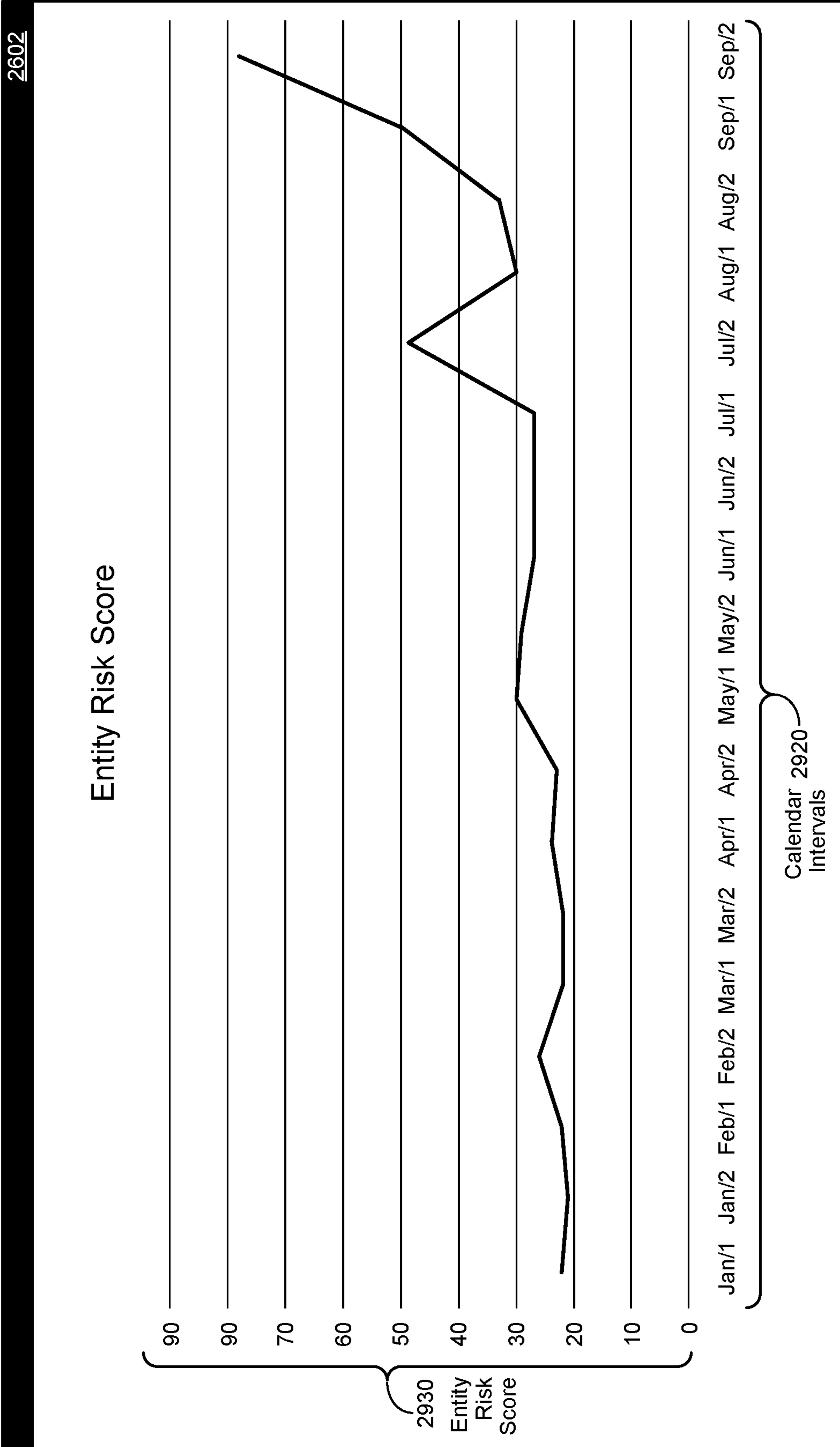

FIGURE 26

1**USING HUMAN FACTORS WHEN
CALCULATING A RISK SCORE**

BACKGROUND OF THE INVENTION

Field of the Invention

The present invention relates in general to the field of computers and similar technologies, and in particular to software utilized in this field. Still more particularly, it relates to a method, system and computer-usable medium for performing a human factors risk operation.

Description of the Related Art

Users interact with physical, system, data, and services resources of all kinds, as well as each other, on a daily basis. Each of these interactions, whether accidental or intended, poses some degree of security risk. However, not all behavior poses the same risk. Furthermore, determining the extent of risk corresponding to individual events can be difficult. In particular, ensuring that an entity is who they claim to be can be challenging.

As an example, a first user may attempt to pose as a second user to gain access to certain confidential information. In this example, the first user may be prevented from accessing the confidential information if it can be determined that they are illegitimately posing as the second user. More particularly, access to the confidential information may be prevented if the identity of the first user is resolved prior to the confidential information actually being accessed. Likewise, the first user's access to the confidential information may be prevented if their identity cannot be resolved to the identity of the second user.

SUMMARY OF THE INVENTION

In one embodiment the invention relates to a computer-implementable method for performing a security operation, comprising: monitoring an entity, the monitoring observing at least one electronically-observable data source; deriving an observable based upon the monitoring of the electronically-observable data source; associating a human factor with the entity; identifying an event of analytic utility, the event of analytic utility being derived from the observable from the electronic data source; analyzing the event of analytic utility, the analyzing the event of analytic utility taking into account the human factor associated with the entity enacting the event of analytic utility; generating a risk score in response to the analyzing, the risk score taking into account the human factor associated with the entity; and, performing the security operation when the risk score meets a security risk parameter.

In another embodiment the invention relates to a system comprising: a processor; a data bus coupled to the processor; and a non-transitory, computer-readable storage medium embodying computer program code, the non-transitory, computer-readable storage medium being coupled to the data bus, the computer program code interacting with a plurality of computer operations and comprising instructions executable by the processor and configured for: monitoring an entity, the monitoring observing at least one electronically-observable data source; deriving an observable based upon the monitoring of the electronically-observable data source; associating a human factor with the entity; identifying an event of analytic utility, the event of analytic utility being derived from the observable from the electronic data

2

source; analyzing the event of analytic utility, the analyzing the event of analytic utility taking into account the human factor associated with the entity enacting the event of analytic utility; generating a risk score in response to the analyzing, the risk score taking into account the human factor associated with the entity; and, performing the security operation when the risk score meets a security risk parameter.

In another embodiment the invention relates to a computer-readable storage medium embodying computer program code, the computer program code comprising computer executable instructions configured for: monitoring an entity, the monitoring observing at least one electronically-observable data source; deriving an observable based upon the monitoring of the electronically-observable data source; associating a human factor with the entity; identifying an event of analytic utility, the event of analytic utility being derived from the observable from the electronic data source; analyzing the event of analytic utility, the analyzing the event of analytic utility taking into account the human factor associated with the entity enacting the event of analytic utility; generating a risk score in response to the analyzing, the risk score taking into account the human factor associated with the entity; and, performing the security operation when the risk score meets a security risk parameter.

BRIEF DESCRIPTION OF THE DRAWINGS

The present invention may be better understood, and its numerous objects, features and advantages made apparent to those skilled in the art by referencing the accompanying drawings. The use of the same reference number throughout the several figures designates a like or similar element.

FIG. 1 depicts an exemplary client computer in which the present invention may be implemented;

FIG. 2 is a simplified block diagram of an endpoint agent;

FIG. 3 is a simplified block diagram showing reference architecture components of a security analytics environment;

FIG. 4 is a simplified block diagram of the operation of a security analytics system used to process information stored in an entity behavior profile (EBP).

FIG. 5 is a simplified block diagram showing certain components of a security analytics system;

FIG. 6 shows a simplified block diagram of an entity behavior profile (EBP);

FIG. 7 is a simplified Venn diagram showing entity interactions between a user entity, a non-user entity, and a data entity;

FIG. 8 shows the enactment of entity interactions between user entities, non-user entities, and data entities;

FIGS. 9a and 9b are a simplified block diagram of a security analytics environment;

FIG. 10 is a simplified block diagram showing the mapping of an event to a security vulnerability scenario;

FIG. 11 is simplified block diagram of process flows associated with the operation of an entity behavior catalog (EBC) system;

FIGS. 12a and 12b are a simplified block diagram showing reference architecture components of an EBC system;

FIG. 13 is a simplified block diagram showing the mapping of entity behaviors to a risk use case scenario;

FIG. 14 is a simplified block diagram of the performance of a human factors risk operation;

FIG. 15 is a simplified block diagram of the performance of an entity behavior meaning derivation operation;

FIG. 16 is a simplified block diagram of the performance of operations to identify an enduring behavioral pattern corresponding to a particular user entity;

FIG. 17 is a graphical representation of an ontology showing example emotional stressors used as a human factor;

FIG. 18 shows a mapping of data sources to emotional stressors used as a human factor;

FIG. 19 is a graphical representation of an ontology showing example organizational dynamics used as a human factor;

FIG. 20 shows a human-centric risk modeling framework;

FIG. 21 shows security risk persona transitions associated with a corresponding outcome-oriented kill chain;

FIGS. 22a and 22b show indicators of behavior corresponding to a security risk persona;

FIG. 23 shows a functional block diagram of process flows associated with the operation of a security analytics system;

FIGS. 24a and 24b show a simplified block diagram of a distributed security analytics system environment;

FIGS. 25a and 25b show tables containing human factors-centric risk model data used to generate a user entity risk score associated with a security vulnerability scenario; and

FIG. 26 shows a user interface (UI) window implemented to graphically display a user entity risk score as it changes over time.

DETAILED DESCRIPTION

A method, system and computer-usable medium are disclosed for performing a human factors risk operation. Certain aspects of the invention reflect an appreciation that the existence of any entity, whether it is an individual user, a group of users, an organization, a device, a system, a network, an account, a domain, an operation, a process, a software application, a service, or a collection of data, represents some degree of security risk. Certain aspects of the invention likewise reflect an appreciation that observation of human behavior can often provide an indication of possible anomalous, abnormal, unexpected, or suspicious behavior, any or all of which may represent a security risk.

Likewise, various aspects of the invention reflect an appreciation that certain human behaviors can be characterized as concerning, and as such, their occurrence may likewise provide an indication of potential security risk. Various aspects of the invention likewise reflect an appreciation that certain human factors, such as cardinal traits, emotional stressors, and organizational dynamics, all of which are described in greater detail herein, often have an associated effect on human behavior. Certain aspects of the invention reflect an appreciation that the quantification of such factors can likewise be advantageously implemented as modifiers to a security risk score value, resulting in a more accurate assessment of security risk.

Likewise, various aspects of the invention reflect an appreciation that known approaches to human-centric risk modeling have certain limitations that often pose challenges for security-related implementation. For example, the Critical Pathway Model (CPM), which has evolved over twenty years of research into insider threat, is based upon retrospective examination and qualitative scoring of case studies that highlight high-profile insider threat cases. However, since CPM depends almost entirely on retrospective qualitative coding of case studies, there is an increased risk of hindsight and confirmation bias informing the outcomes and creation of its categories.

Accordingly, certain aspects of the invention reflect an appreciation that a particular entity can be assigned a measure of risk according to its respective attributes, behaviors, associated behavioral models, and resultant inferences contained in an associated profile. As an example, a first profile may have an attribute that its corresponding entity works in the human resource department, while a second profile may have an attribute that its corresponding entity is an email server. To continue the example, the first profile may have an associated behavior that indicates its corresponding entity is not acting as they did the day before, while the second profile may have an associated behavior that indicates its corresponding entity is connecting to a suspicious IP address.

To further continue the example, the first profile may have a resultant inference that its corresponding entity is likely to be leaving the company, while the second profile may have a resultant inference that there is a high probability its corresponding entity is compromised. Accordingly, various aspects of the invention reflect an appreciation that a catalog of such behaviors, and associated profiles, can assist in identifying certain entity indicators of behavior, described in greater detail herein. Likewise, certain aspects of the invention reflect an appreciation that such entity indicators of behavior may be determined to be anomalous, abnormal, unexpected, or suspicious, or some combination thereof, as likewise described in greater detail herein.

For the purposes of this disclosure, computer-readable media may include any instrumentality or aggregation of instrumentalities that may retain data and/or instructions for a period of time. Computer-readable media may include, without limitation, storage media such as a direct access storage device (e.g., a hard disk drive or solid state drive), a sequential access storage device (e.g., a tape disk drive), optical storage device, random access memory (RAM), read-only memory (ROM), electrically erasable programmable read-only memory (EEPROM), and/or flash memory; as well as communications media such as wires, optical fibers, microwaves, radio waves, and other electromagnetic and/or optical carriers; and/or any combination of the foregoing.

FIG. 1 is a generalized illustration of an information handling system 100 that can be used to implement the system and method of the present invention. The information handling system 100 includes a processor (e.g., central processor unit or “CPU”) 102, input/output (I/O) devices 104, such as a display, a keyboard, a mouse, and associated controllers, a storage system 106, and various other subsystems 108. In various embodiments, the information handling system 100 also includes network port 110 operable to connect to a network 140, which is likewise accessible by a service provider server 142. The information handling system 100 likewise includes system memory 112, which is interconnected to the foregoing via one or more buses 114. System memory 112 further includes operating system (OS) 116 and in various embodiments may also include a security analytics system 118. In one embodiment, the information handling system 100 is able to download the security analytics system 118 from the service provider server 142. In another embodiment, the security analytics system 118 is provided as a service from the service provider server 142.

In various embodiments, the security analytics system 118 may be implemented to perform a security analytics operation, described in greater detail herein. In certain embodiments, the security analytics operation improves processor efficiency, and thus the efficiency of the information handling system 100, by facilitating security analytics functions.

5

As will be appreciated, once the information handling system **100** is configured to perform the security analytics operation, the information handling system **100** becomes a specialized computing device specifically configured to perform the security analytics operation and is not a general purpose computing device. Moreover, the implementation of the security analytics system **118** on the information handling system **100** improves the functionality of the information handling system **100** and provides a useful and concrete result of performing security analytics functions to mitigate security risk.

In certain embodiments, the security analytics system **118** may be implemented to include an entity behavior catalog (EBC) system **120**, a human factors framework **122**, and a risk scoring system **124**, or a combination thereof. In certain embodiments, the EBC system **120** may be implemented to catalog entity behavior, as described in greater detail herein. In certain embodiments, the human factors framework **122** may be implemented to perform a human factors risk operation as likewise described in greater detail herein. Likewise, as described in greater detail herein, the security risk scoring system **124** may be implemented in various embodiments to perform certain security risk scoring operations.

FIG. **2** is a simplified block diagram of an endpoint agent implemented in accordance with an embodiment of the invention. As used herein, an endpoint agent **206** broadly refers to a software agent used in combination with an endpoint device **204** to establish a protected endpoint **202**. Skilled practitioners of the art will be familiar with software agents, which are computer programs that perform actions on behalf of an entity. As likewise used herein, an entity broadly refers to something that exists as itself, whether physically or abstractly.

In certain embodiments, the identity of a particular entity may be known or unknown. In certain embodiments, an entity may be a user entity, a non-user entity, a data entity, or a combination thereof. As used herein, a user entity broadly refers to an animate entity whose identity can be described by certain attributes and is capable of exhibiting or enacting certain user entity behaviors, as described in greater detail herein, but is incapable of exhibiting or enacting a non-user entity or data entity behavior. Examples of a user entity include an individual person, a group of people, an organization, or a government.

As likewise used herein, a non-user entity broadly refers to an inanimate entity whose identity can be described by certain attributes and is capable of exhibiting or enacting certain non-user entity behaviors, as described in greater detail herein, but is incapable of exhibiting or enacting a user entity or data entity behavior. In certain embodiments, a non-user entity may embody a physical form. Examples of a non-user entity include an item, a device, such as endpoint **204** and edge devices, a network, a system, an operation, and a process. Other examples of a non-user entity include a resource, such as a geographical location or formation, a physical facility, a venue, a software application, and a service, such as a service operating in a cloud environment.

A data entity, as used herein, broadly refers to an inanimate entity that is a collection of information that can be described by certain attributes and is capable of exhibiting or enacting certain data entity behaviors, as described in greater detail herein, but is incapable of enacting a user entity or non-user entity behavior. In certain embodiments, a data entity may include some form of a digital instantiation of information. Examples of a data entity include an account, a user identifier (ID), a cryptographic key, a computer file,

6

a text or email message, an audio or video recording, a network address, and a domain.

An entity behavior, as used herein, broadly refers to any behavior exhibited or enacted by an entity that can be electronically observed during the occurrence of an entity interaction. Accordingly, a user entity behavior, as used herein, broadly refers to the enactment of an entity behavior by an associated user entity. Likewise, as used herein, a non-user entity behavior broadly refers to the enactment of an entity behavior by an associated non-user entity. As likewise used herein, a data entity behavior broadly refers to the enactment of an entity behavior by an associated data entity.

As used herein, an entity interaction broadly refers to the occurrence of an action associated with a first entity being influenced by another action associated with a second entity. In certain embodiments, an entity interaction may include the occurrence of at least one event enacted by one entity when interacting with another. In certain embodiments, an event associated with an entity interaction may include at least one entity attribute, described in greater detail herein, and at least one entity behavior, likewise described in greater detail herein. As an example, a user entity may perform an action, such as sending a text message to some other user entity who in turn replies with a response. In this example, the other user entity's action of responding is influenced by the user entity's action of sending the text message.

As another example, a user may attempt to use an electronic access card to enter a secured building at a certain time. In this example, the use of the access card to enter the building is the action and the reading of the access card makes the user's physical behavior electronically-observable. As another example, a first user may physically transfer a document to a second user, which is captured by a video surveillance system. In this example, the physical transfer of the document from the first user to the second user is the action. Likewise, the video record of the transfer makes the first and second user's physical behavior electronically-observable.

In various approaches, a software agent may be autonomous or work in concert with another agent, or an entity, or a combination of the two, as described in greater detail herein. In certain of these approaches, the software agent may be implemented to autonomously decide if a particular action is appropriate for a particular event, or an observed entity behavior, or a combination of the two, as likewise described in greater detail herein. As used herein, an event broadly refers to the occurrence of at least one action performed by an entity. In certain embodiments, the action may be directly, or indirectly, associated with an entity behavior, described in greater detail herein. In certain embodiments, the entity behavior may include an entity's physical behavior, cyber behavior, or a combination thereof, as likewise described in greater detail herein.

As an example, a first user may attach a binary file infected with a virus to an email that is subsequently sent to a second user. In this example, the act of attaching the binary file to the email is directly associated with an entity behavior enacted by the first user. In certain embodiments, the action may be indirectly associated with an entity behavior. To continue the example, the recipient of the email may open the infected binary file, and as a result, infect their computer with malware. To further continue the example, the act of opening the infected binary file is directly associated with an entity behavior enacted by the second user. However, the infection of the email recipient's computer by the infected

binary file is indirectly associated with the described entity behavior enacted by the second user.

An endpoint device **204**, as likewise used herein, refers to an information processing system such as a personal computer, a laptop computer, a tablet computer, a personal digital assistant (PDA), a smart phone, a mobile telephone, a digital camera, a video camera, or other device that is capable of storing, processing and communicating data. In certain embodiments, such an endpoint device **204** may be implemented as a non-user entity. In certain embodiments, the communication of the data may take place in real-time or near-real-time. As used herein, real-time broadly refers to processing and providing information within a time interval brief enough to not be discernable by a user entity, described in greater detail herein. As an example, a cellular phone conversation may be used to communicate information in real-time, while an instant message (IM) exchange may be used to communicate information in near real-time.

In certain embodiments, the communication of the information may take place asynchronously. For example, an email message may be stored on an endpoint device **204** when it is offline. In this example, the information may be communicated to its intended recipient once the endpoint device **204** gains access to a network **140**. In certain embodiments, the network **140** may be a private network (e.g., an enterprise network), a semi-public network (e.g., a service provider core network), or a public network (e.g., the Internet).

A protected endpoint **202**, as likewise used herein, broadly refers to a policy-based approach to network security that typically requires an endpoint device **204** to comply with particular criteria before it is granted access to network resources. As an example, an endpoint device **204** may be required to have a particular operating system (OS), or version thereof, a Virtual Private Network (VPN) client, anti-virus software with current updates, and so forth. In certain embodiments, the protected endpoint **202** may be implemented to perform operations associated with providing real-time resolution of the identity of an entity at a particular point in time, as described in greater detail herein. In certain embodiments, the protected endpoint **202** may be implemented to provide temporal information associated with such operations.

As used herein, temporal information broadly refers to a measure of time (e.g., a date, timestamp, etc.), a measure of an interval of time (e.g., a minute, hour, day, etc.), or a measure of an interval of time (e.g., two consecutive weekdays days, or between Jun. 3, 2017 and Mar. 4, 2018, etc.). In certain embodiments, the temporal information may be associated with an event associated with a particular point in time. As used herein, such a temporal event broadly refers to an occurrence of an action enacted by, or associated with, an entity at a particular point in time.

Examples of such temporal events include making a phone call, sending a text or an email, using a device, such as an endpoint device **204**, accessing a system, and entering a physical facility. Other examples of temporal events include uploading, transferring, downloading, modifying, or deleting data, such as data stored in a datastore, or accessing a service. Yet other examples of temporal events include entity interactions between two or more users, entity interactions between a user and a device, entity interactions between a user and a network, and entity interactions between a user and a resource, whether physical or otherwise. Yet still other examples of temporal events include a

change in name, address, physical location, occupation, position, role, marital status, gender, association, affiliation, or assignment.

As likewise used herein, temporal event information broadly refers to temporal information associated with a particular event. In various embodiments, the temporal event information may include certain types of content. In certain embodiments, such types of content may include text, unstructured data, structured data, graphical images, photographs, audio recordings, video recordings, and so forth. In certain embodiments, the temporal event information may include metadata. In various embodiments, the metadata may include temporal event attributes, which in turn may include certain entity identifier types or classifications, described in greater detail herein.

In certain embodiments, the real-time resolution of the identity of an entity at a particular point in time may be based upon contextual information associated with a particular entity behavior. As used herein, contextual information broadly refers to any information, directly or indirectly, individually or in combination, related to a particular entity behavior. In certain embodiments, entity behavior may include an entity's physical behavior, cyber behavior, or a combination thereof. As likewise used herein, physical behavior broadly refers to any entity behavior occurring within a physical realm. More particularly, physical behavior may include any action enacted by an entity that can be objectively observed, or indirectly inferred, within a physical realm.

Cyber behavior, as used herein, broadly refers to any behavior occurring in cyberspace, whether enacted by an individual entity, a group of entities, or a system acting at the behest of an individual entity, a group of entities, or other entity described in greater detail herein. More particularly, cyber behavior may include physical, social, or mental actions enacted by a user entity that can be objectively observed, or indirectly inferred, within cyberspace. As an example, a user may use an endpoint device **204** to access and browse a particular website on the Internet. In this example, the individual actions performed by the user to access and browse the website constitute a cyber behavior.

As another example, a user may use an endpoint device **204** to download a data file from a particular system at a particular point in time. In this example, the individual actions performed by the user to download the data file, and associated temporal information, such as a time-stamp associated with the download, constitute a cyber behavior. In these examples, the actions are enacted within cyberspace, in combination with associated temporal information, makes them electronically-observable.

As likewise used herein, cyberspace broadly refers to a network **140** environment capable of supporting communication between two or more entities. In certain embodiments, the entity may be a user, an endpoint device **204**, or various resources, described in greater detail herein. In certain embodiments, the entities may include various endpoint devices **204** or resources operating at the behest of an entity, such as a user. In certain embodiments, the communication between the entities may include audio, image, video, text, or binary data.

As described in greater detail herein, the contextual information may include an entity's authentication factors. Contextual information may likewise include various temporal identity resolution factors, such as identification factors associated with the entity, the date/time/frequency of various entity behaviors, the entity's location, a user entity's role or position in an organization, their associated access

rights, and certain user gestures employed by a user in the enactment of a user entity behavior. Other contextual information may likewise include various user entity interactions, whether the interactions are with a non-user entity, a data entity, or another user entity. In certain embodiments, user entity behaviors, and their related contextual information, may be collected at particular points of observation, and at particular points in time, described in greater detail herein. In certain embodiments, a protected endpoint **202** may be implemented as a point of observation for the collection of entity behavior and contextual information.

In certain embodiments, the endpoint agent **206** may be implemented to universally support a variety of operating systems, such as APPLE MACINTOSH®, MICROSOFT WINDOWS®, LINUX®, ANDROID® and so forth. In certain embodiments, the endpoint agent **206** may be implemented to interact with the endpoint device **204** through the use of low-level hooks **212** at the operating system level. It will be appreciated that the use of low-level hooks **212** allows the endpoint agent **206** to subscribe to multiple events through a single hook. Consequently, multiple functionalities provided by the endpoint agent **206** can share a single data stream, using only those portions of the data stream they may individually need. Accordingly, system efficiency can be improved and operational overhead reduced.

In certain embodiments, the endpoint agent **206** may be implemented to provide a common infrastructure for pluggable feature packs **208**. In various embodiments, the pluggable feature packs **208** may provide certain security management functionalities. Examples of such functionalities may include various anti-virus and malware detection, data loss protection (DLP), insider threat detection, and so forth. In certain embodiments, the security management functionalities may include one or more functionalities associated with providing real-time resolution of the identity of an entity at a particular point in time, as described in greater detail herein.

In certain embodiments, a particular pluggable feature pack **208** may be invoked as needed by the endpoint agent **206** to provide a given functionality. In certain embodiments, individual features of a particular pluggable feature pack **208** are invoked as needed. In certain embodiments, the individual features of a pluggable feature pack **208** may be invoked by the endpoint agent **206** according to the occurrence of a particular entity behavior. In certain embodiments, the individual features of a pluggable feature pack **208** may be invoked by the endpoint agent **206** according to the occurrence of a particular temporal event, described in greater detail herein. In certain embodiments, the individual features of a pluggable feature pack **208** may be invoked by the endpoint agent **206** at a particular point in time. In these embodiments, the method by which a particular entity behavior, temporal event, or point in time is selected is a matter of design choice.

In certain embodiments, the individual features of a pluggable feature pack **208** may be invoked by the endpoint agent **206** according to the context of a particular entity behavior. As an example, the context may be a user enacting a particular user entity behavior, their associated risk classification, which resource they may be requesting, the point in time the user entity behavior is enacted, and so forth. In certain embodiments, the pluggable feature packs **208** may be sourced from various cloud services **216**. In certain embodiments, the pluggable feature packs **208** may be dynamically sourced from various cloud services **216** by the endpoint agent **206** on an as-needed basis.

In certain embodiments, the endpoint agent **206** may be implemented with additional functionalities, such as event analytics **210**. In various embodiments, the event analytics **210** functionality may include analysis of certain entity behaviors, described in greater detail herein. Those of skill in the art will recognize that many such embodiments and examples are possible. Accordingly, the foregoing is not intended to limit the spirit, scope or intent of the invention.

FIG. **3** is a simplified block diagram showing reference architecture components of a security analytics environment. In certain embodiments, the security analytics environment **300** may be implemented to include a security analytics system **118**, a network **140**, one or more endpoint devices **204**, and one or more edge devices **304**. In various embodiments, the security analytics system **118** may be implemented to perform certain security analytics operations. As used herein, a security analytics operation broadly refers to any operation performed to determine a security risk corresponding to a particular event, or an entity behavior enacted by an associated entity, or a combination thereof.

In certain embodiments, the security analytics system **118** may be implemented as both a source and a sink of entity behavior information **302**. As used herein, entity behavior information **302** broadly refers to any information related to the enactment of a behavior by an associated entity. In various embodiments, the security analytics system **118** may be implemented to serve requests for certain entity behavior information **302**. In certain embodiments, the edge device **304** and the endpoint agent **206**, individually or in combination, may provide certain entity behavior information **302** to the security analytics system **118**, respectively using push or pull approaches familiar to skilled practitioners of the art.

As used herein, an edge device **304** broadly refers to a device providing an entry point into a network, such as the network **140** shown in FIG. **3**. Examples of such edge devices **304** include routers, routing switches, integrated access devices (IADs), multiplexers, wide-area network (WAN) access devices, network security appliances, and so forth. In certain embodiments, the edge device **304** may be implemented in a bridge, a firewall, or a passive monitoring configuration. In certain embodiments, the edge device **304** may be implemented as software running on an information processing system.

In certain embodiments, the edge device **304** may be implemented to provide access to the security analytics system **118** via the network **140**. In certain embodiments, the edge device **304** may be implemented to provide access to and from the network **140**, a third party network **310**, and a security analytics service **308**, or a combination thereof. In certain embodiments, the network **140** and third party networks **310** may respectively be a private network (e.g., an enterprise network), a semi-public network (e.g., a service provider core network), or a public network (e.g., the Internet). In certain embodiments, the edge device **304** may be implemented to provide access to a third party system **312** via the third party network **310**.

In certain embodiments, the edge device **304** may be implemented to provide support for a variety of generic services, such as directory integration, logging interfaces, update services, and bidirectional risk/context flows associated with various security analytics operations, described in greater detail herein. In certain embodiments, the edge device **304** may be implemented to provide temporal information, likewise described in greater detail herein, associated with the provision of such services. In certain embodiments, the edge device **304** may be implemented as a generic device configured to host various network communications,

data processing, and security management capabilities. In certain embodiments, such capabilities may include the performance of operations associated with providing real-time resolution of the identity of an entity at a particular point in time. In certain embodiments, such operations may likewise include the provision of associated temporal information (e.g., time stamps).

In certain embodiments, the edge device **304** may be implemented to receive network requests and context-sensitive entity behavior information **302**, described in greater detail herein, from an endpoint agent **206**. The edge device **304** may be implemented in certain embodiments to receive enriched entity behavior information **302** from the endpoint agent **206**. In various embodiments, certain entity behavior information **302** may be enriched by an associated endpoint agent **206** attaching contextual information to a request.

In various embodiments, the contextual information may be embedded within a network request, which is then provided as enriched entity behavior information **302**. In various embodiments, the contextual information may be concatenated, or appended, to a request, which in turn is provided as enriched entity behavior information **302**. In certain of these embodiments, the enriched entity behavior information **302** may be unpacked upon receipt by the edge device **304** and parsed to separate the request and its associated contextual information. Those of skill in the art will recognize that one possible disadvantage of such an approach is that it may perturb certain Intrusion Detection System and/or Intrusion Detection Prevention (IDS/IDP) systems implemented on the network **140** or third party network **310**.

In various embodiments, new flow requests may be accompanied by a contextual information packet sent to the edge device **304**. In certain of these embodiments, the new flow requests may be provided as enriched entity behavior information **302**. In certain embodiments, the endpoint agent **206** may also send updated contextual information to the edge device **304** once it becomes available. As an example, an endpoint agent **206** may share a list of files that have been read by a current process at any point in time once the information has been collected. To continue the example, such a list of files may be used to determine which data the endpoint agent **206** may be attempting to exfiltrate.

In certain embodiments, such service requests may be associated with temporal event information, described in greater detail herein. Consequently, such requests can be enriched by the addition of contextual entity information (e.g., UserAccount, interactive/automated, data-touched, etc.). Accordingly, the edge device **304** can then use this information to manage the appropriate response to submitted requests. In certain embodiments, such requests may be associated with providing real-time resolution of the identity of an entity at a particular point in time.

In certain embodiments, point analytics processes executing on the edge device **304** may request a particular service. As an example, risk scores on a per-entity basis may be requested. In certain embodiments, the service may be requested from the security analytics system **118**. In certain embodiments, the service may be requested from a security analytics service **308**. In certain embodiments, the security analytics system **118** may be implemented to provide the security analytics service **308**. In certain embodiments, hosting of the security analytics service **308** may be provided by a cloud infrastructure familiar to those of skill in the art.

In certain embodiments, the endpoint agent **206** may be implemented to update the security analytics system **118**

with entity behavior information **302** and associated contextual information, thereby allowing an offload of certain analytics processing overhead. In various embodiments, this approach may be implemented to provide longitudinal risk scoring, which assesses security risk associated with certain entity behavior during a particular interval of time. In certain embodiments, the security analytics system **118** may be implemented to perform risk-adaptive operations to access risk scores associated with the same user entity, but accrued on different endpoint devices **204**. Certain embodiments of the invention reflect an appreciation that such an approach may prove advantageous when an adversary is “moving sideways” through a network environment, using different endpoint devices **204** to collect information.

Certain embodiments of the invention reflect an appreciation that enriched entity behavior information **302** will likely not be available for provision to the edge device **304** if an endpoint agent **206** is not implemented for a corresponding endpoint device **204**. However, the lack of such enriched entity behavior information **302** may be accommodated in various embodiments, albeit with reduced functionality associated with certain security analytics operations.

In certain embodiments, the edge device **304** may be implemented as a generic device configured to host various network communications, data processing, and security management capabilities. In certain embodiments, such capabilities may include the performance of operations associated with providing real-time resolution of the identity of an entity at a particular point in time. In certain embodiments, such operations may likewise include the provision of associated temporal information (e.g., time stamps).

In certain embodiments, the security analytics system **118** may be implemented in different operational configurations. In various embodiments, the security analytics system **118** may be implemented for use by the endpoint agent **206**. In various embodiments, the security analytics system **118** may be implemented for use by the endpoint agent **206** and the edge device **304** in combination. In various embodiments, the security analytics service **308** may likewise be implemented for use by the endpoint agent **206**, the edge device **304**, and the security analytics system **118**, individually or in combination. In certain of these embodiments, the security analytics system **118** may be primarily oriented to performing security risk assessment operations related to one or more entity’s associated entity behaviors.

In certain embodiments, the security analytics system **118** may be primarily oriented to applying risk mitigations in a way that maximizes security effort return-on-investment (ROI). In certain embodiments, such approaches may be accomplished by providing additional contextual and entity behavior information associated with entity requests. As an example, a web gateway may not concern itself with why a particular file is being requested by a certain entity at a particular point in time. Accordingly, if the file cannot be identified as malicious or harmless, there is no context available to determine how, or if, to proceed.

To extend the example, the edge device **304** and security analytics system **118** may be coupled such that requests can be contextualized and fitted into a framework that evaluates their associated risk. Certain embodiments of the invention reflect an appreciation that such an approach works well with web-based data loss protection (DLP) approaches, as each transfer is no longer examined in isolation, but in the broader context of an identified user entity’s actions, at a particular time.

In certain embodiments, the security analytics system **118** may be primarily oriented to maximally leverage contextual information associated with various entity behaviors within the system. In certain embodiments, data flow tracking is performed by one or more endpoint agents **206**, which allows the quantity and type of information associated with particular entities to be measured. In turn, this information may be used to determine how a particular edge device **304** handles requests. Skilled practitioners of the art will recognize that many such embodiments and examples are possible. Accordingly, the foregoing is not intended to limit the spirit, scope or intent of the invention.

FIG. **4** is a simplified block diagram of the operation of a security analytics system implemented in accordance with an embodiment of the invention to process information stored in an entity behavior profile (EBP). In various embodiments, a security analytics system **118** may be implemented to use certain information stored in an EBP **420** to perform a security analytics operation, described in greater detail herein. As used herein, an entity behavior profile **420** broadly refers to a collection of information that uniquely describes a particular entity's identity and their associated behavior, whether the behavior occurs within a physical realm or cyberspace. In certain embodiments, the security analytics system **118** may be implemented to use certain event **402** and human factor **406** information in the performance of a particular security analytics operation.

In certain embodiments, the security analytics system **118** may be implemented with an entity behavior catalog (EBC) system **120**, a human factors framework **122**, and a risk scoring system **124**, or a combination thereof. In various embodiments, the human factors framework **122** may be implemented to receive and process certain human factor **406** information to generate one or more human factors **430**. In certain embodiments, the EBC system **120** may be implemented to store the resulting human factors **430** in a user entity profile **422**, described in greater detail herein.

As used herein, human factors **430** broadly refer to certain cardinal traits, emotional stressors, and organizational dynamics that individually, or in combination, may influence, one way or another, the entity behavior of an associated user entity. As an example, an employee experiencing financial stress may attempt to exfiltrate proprietary data in exchange for compensation from a competitor. As used herein, cardinal traits broadly refers to a user entity's consistent and enduring observed entity behavioral patterns. As likewise used herein, an emotional stressor broadly refers to any event involving an end user entity such that it may have an emotional influence upon, or otherwise affect, a user entity's behavior. An organizational dynamic, as likewise used herein, broadly refers to any event that occurs within an organization, or large group, that may have an operational influence upon, or otherwise affect, a user entity's behavior.

In various embodiments, the human factors framework **122** may be implemented with a human factors analytics **408** module, a contextual security risk persona management **410** module, and certain user entity behavioral rules **412**, or a combination thereof. In certain embodiments, the human factors analytics **408** module may be implemented to perform a human factors analytics operation. As used herein, a human factors analytics operation broadly refers to any operation performed to analyze the effect that certain human factors, individually or in combination, may have on the security risk corresponding to an entity behavior enacted by an associated user entity. In certain embodiments, the security risk persona management **410** module may be implemented to create, revise, update, or otherwise manage a

particular security risk persona, described in greater detail herein, associated with a particular user entity.

In various embodiments, the human factors framework **122** may be implemented to create, revise, update, or otherwise manage certain user behavioral rules **412** associated with a particular user entity. In certain embodiments, the user behavioral rules **412** may be implemented to determine whether a particular user entity behavior is anomalous, abnormal, unexpected, suspicious, or some combination thereof. In certain embodiments, the human factors framework **122** may be implemented to use the user behavioral rules **412** to determine whether certain user entity behaviors that are determined to be anomalous, abnormal, unexpected, suspicious, or some combination thereof, may likewise be considered to be a concerning behavior within a particular context.

In various embodiments, the EBC system **120** may be implemented to process a stream **404** of event **402** information to generate, revise, and otherwise manage certain information contained in an EBP **420**. In certain embodiments, the EBP **420** may be implemented to include a user entity profile **422**, a non-user entity profile **440**, a data entity profile **450**, one or more entity risk scores **460**, one or more entity states **462**, and one or more entity models, or a combination thereof. As used herein, a user entity profile **422** broadly refers to a collection of information that uniquely identifies and describes a particular user entity identity and their associated entity behavior, whether the behavior occurs within a physical realm or cyberspace. As likewise used herein, a non-user entity profile **440** broadly refers to a collection of information that uniquely identifies and describes a particular non-user entity identity and its associated entity behavior, whether the behavior occurs within a physical realm or cyberspace. A data entity profile **450**, as likewise used herein, broadly refers to a collection of information that uniquely identifies and describes a particular data entity, described in greater detail herein, and its associated entity behavior, whether the behavior occurs within a physical realm or cyberspace.

In various embodiments, the user entity profile **422** may be implemented to contain certain attribute **424**, behavior **426**, and inference **430** data related to a particular user entity. In certain embodiments, the attribute **424** data may include information associated with a particular user entity's inherent and learned **426** attributes. In certain embodiments, the attribute **424** data may be used by the human factors framework **122** to gain knowledge or insights about a particular user entity and their associated user entity behavior.

In certain embodiments, a user entity's inherent and learned attributes **426** may include known facts, such as their location and contact information, their job title and responsibilities, their peers and manager, and so forth. In certain embodiments, a user entity's inherent and learned attributes **426** may be derived through observation, as described in greater detail herein. Examples of such derived inherent and learned attributes **426** include which devices a user entity may typically use, their usual work hours and habits, their interactions with other entities, and so forth.

In certain embodiments, the behavior **428** data may include information associated with a particular user entity's human factors **430**, described in greater detail herein. In certain embodiments, the behavior **428** data may include information associated with a particular user entity's interactions with other entities, likewise described in greater detail herein. In certain embodiments, the inference **432** data may include information associated with certain security

risk use cases, security risk personas, and security vulnerability scenarios **434**, or a combination thereof, related to a particular user entity.

As used herein, a security risk use case broadly refers to a set of indicators of behavior that create a security risk narrative that can be used to adaptively draw inferences, described in greater detail herein, from entity behavior enacted by a particular entity. As used herein, an indicator of behavior (IOB) broadly refers to an abstracted description of the inferred intent of the enactment of one or more entity behaviors, described in greater detail herein, by an associated entity. In certain embodiments, information related to the enactment of a particular entity behavior may be stored in the form of an observable. As used herein, an observable broadly refers to certain event information corresponding to an electronically-observable behavior enacted by an entity. In certain embodiments, an IOB is derived from a group of associated observables corresponding to the enactment of a particular entity behavior.

As an example, a user entity may enact certain entity behavior that results in the occurrence of one or more operating system (OS) events, a cloud access security broker (CASB) event, a firewall access event, and a data file download event. In this example, the events are observables. To continue the example, an IOB of “user downloaded document” can be inferred from the observables.

Skilled practitioners of the art will be familiar with the concept of an indicator of compromise (IOC), which is an artifact on a system or network that indicate a malicious activity has occurred. Known examples of IOCs include file hashes, network addresses, domain names, and so forth. As such, IOCs are useful in identifying and preventing adversary attacks based upon unique signatures of malware or other tools used by an attacker. However, IOCs are less effective against insider threats, such as data exfiltration. Accordingly, certain embodiments of the invention reflect an appreciation that IOBs can provide a description of the approach an attack is taking as it is occurring, unlike an IOC, which provides evidence of an attack after it has taken place.

As likewise used herein, a security risk persona broadly refers to a descriptor characterizing an entity behavioral pattern exhibited by a user entity during the enactment of certain user entity behaviors. In certain embodiments, the security risk persona may directly or indirectly characterize, or otherwise reference, one or more user entity behaviors. As an example, a user entity may exhibit user entity behaviors typically associated with data stockpiling. In this example, the security risk persona for the user entity might be “Data Stockpiler,” or “Stockpiler.” Likewise, as used herein, a security vulnerability scenario broadly refers to a grouping of one or more security risk use cases that represent a particular class of security vulnerability.

In various embodiments, the human factors framework **122** may be implemented in combination with the EBC system **122** to store certain human factors information in the EBP **420** and retrieve it therefrom. In certain embodiments, the attribute **424**, behavior **428**, and inference **432** data stored in the user entity profile **422** may be used individually, or in combination, by the human factors framework **122** to perform a human factors risk operation. As used herein, a human factors risk operation broadly refers to any operation performed to identify a human factor **430**, classify it into a corresponding human factor class, or determine the effect it may have on the security risk represented by an associated IOB, or a combination thereof.

In various embodiments, the security analytics system **118** may be implemented to use certain information stored in the

EBP **420** to draw inferences **432** regarding the trustworthiness of a particular entity. In certain embodiments, as described in greater detail herein, the drawing of the inferences may involve comparing a new entity behavior to known past behaviors enacted by the entity. In certain embodiments, new entity behavior that is different from known past behaviors may represent entity behavior signifying an associated security risk.

In certain embodiments, the risk scoring system **124** may be implemented to use such inferences **432**, and other information stored in the EBP **420** to generate one or more entity risk scores **460**. In certain embodiments, the resulting entity risk scores **460** may be quantitative, qualitative, or combination of the two. In certain embodiments, the EBC system **120** may be implemented to manage information associated with such risk scores **460** in the EBP **420**.

As used herein, entity state **462** broadly refers to the context of a particular event as it relates to an associated entity behavior. In certain embodiments, the entity state **462** may be a long-term entity state or a short-term entity state. As used herein, a long-term entity state **462** broadly relates to an entity state **462** that persists for an extended interval of time, such as six months or a year. As likewise used herein, a short-term entity state **462** broadly relates to an entity state **462** that occurs for a brief interval of time, such as a few minutes or a day. In various embodiments, the method by which an entity state’s **462** associated interval of time is considered to be long-term or short-term is a matter of design choice.

As an example, a particular user may have a primary work location, such as a branch office, and a secondary work location, such as their company’s corporate office. In this example, the user’s primary and secondary offices respectively correspond to the user’s location, whereas the presence of the user at either office corresponds to an entity state **462**. To continue the example, the user may consistently work at their primary office Monday through Thursday, but at their company’s corporate office on Fridays. To further continue the example, the user’s presence at their primary work location may be a long-term entity state **462**, while their presence at their secondary work location may be a short-term entity state **462**. Consequently, the long-term user entity state **462** on Monday through Thursday will typically be “working at the branch office” and the short-term entity state **462** on Friday will likely be “working at the corporate office.”

As used herein, an entity behavior model **464** broadly refers to a collection of information related to an entity’s historical entity behavior over a particular period of time. In certain embodiments, an entity behaviour model **464** may be used by the security analytics system **118** to gain insight into how unexpected a set of events may be. As an example, an entity behavior model **464** may include information related to where a particular user entity works, which devices they may use and locations they may login from, who they may communicate with, and so forth. Certain embodiments of the invention reflect an appreciation that such entity behavior models **454** can be useful when comparing currently observed entity behaviors to past observations in order to determine how unusual a particular entity behavior may be.

For example, a user may have multiple entity behavior models **454**, each associated with a particular channel, which as used herein broadly refers to a medium capable of supporting the electronic observation of entity behavior, such as a keyboard, a network, a video stream, and so forth. To continue the example, the user may have a particular set of people he sends emails to from his desktop computer, and

does so in an orderly and methodical manner, carefully choosing his words, and writing longer than average messages compared to his peers. Consequently, analysis of such an email message will likely indicate it was authored by the user and not someone else.

In various embodiments, the security analytics system **118** may be implemented to perform a security operation **470**. As used herein, a security operation **470** broadly refers to any action performed to mitigate an identified security risk. In certain embodiments, the security analytics system **118** may be implemented to identify the security risk. In various embodiments, the security analytics system **118** may be implemented to use certain information contained in the EBP **420** to either identify the security risk, or perform the security operation **470**, or a combination of the two. In certain embodiments, the security system **118** may be implemented to perform the security operation **470** automatically or semi-automatically. Those of skill in the art will recognize that many such embodiments are possible. Accordingly, the foregoing is not intended to limit the spirit, scope, or intent of the invention.

FIG. **5** is a simplified block diagram showing certain components of a security analytics system implemented in accordance with an embodiment of the invention. In certain embodiments, the security analytics system **118** shown in FIG. **5** may include an event queue analytics **504** sub-system. In certain embodiments, the event queue analytics **504** sub-system may be implemented to include an enrichment **506** module and a streaming analytics **508** module. In certain embodiments, the security analytics system **118** may be implemented to provide log storage, reporting, and analytics capable of performing streaming **508** and on-demand **410** analytics operations.

In certain embodiments, such operations may be associated with defining and managing an entity behavior profile (EBP), described in greater detail herein. In certain embodiments, an EBP may be implemented as an adaptive trust profile (ATP). In certain embodiments, as likewise described in greater detail herein, an EBP may be implemented to detect entity behavior that may be anomalous, abnormal, unexpected, or suspicious, or a combination thereof.

In certain embodiments, the security analytics system **118** may be implemented to provide a uniform platform for storing events and contextual information associated with various entity behaviors and performing longitudinal analytics. As used herein, longitudinal analytics broadly refers to performing analytics of entity behaviors occurring over a particular period of time. As an example, an entity may iteratively attempt to access certain proprietary information stored in various locations. In addition, the attempts may occur over a brief period of time. To continue the example, the fact that the information the user is attempting to access is proprietary, that it is stored in various locations, and the attempts are occurring in a brief period of time, in combination, may indicate the user entity behavior enacted by the user is suspicious. As another example, certain entity identifier information (e.g., a user name) associated with an entity may change over time. In this example, a change in the entity's user name, during a particular time period or at a particular point in time, may represent suspicious entity behavior.

In certain embodiments, the security analytics system **118** may be implemented to be scalable. In certain embodiments, the security analytics system **118** may be implemented in a centralized location, such as a corporate data center. In these embodiments, additional resources may be added to the security analytics system **118** as needs grow. In certain

embodiments, the security analytics system **118** may be implemented as a distributed system. In these embodiments, the security analytics system **118** may span multiple information handling systems. In certain embodiments, the security analytics system **118** may be implemented in a cloud environment. In certain embodiments, the security analytics system **118** may be implemented in a virtual machine (VM) environment. In such embodiments, the VM environment may be configured to dynamically and seamlessly scale the security analytics system **118** as needed. Skilled practitioners of the art will recognize that many such embodiments are possible. Accordingly, the foregoing is not intended to limit the spirit, scope or intent of the invention.

In certain embodiments, an event stream collector **502** may be implemented to collect event and related contextual information, described in greater detail herein, associated with various entity behaviors. In these embodiments, the method by which the event and contextual information is selected to be collected by the event stream collector **502** is a matter of design choice. In certain embodiments, the event and contextual information collected by the event stream collector **502** may be processed by an enrichment module **506** to generate enriched entity behavior information. In certain embodiments, the enrichment may include certain contextual information related to a particular entity behavior or event. In various embodiments, the enrichment may include certain temporal information, such as timestamp information, related to a particular entity behavior or event.

In certain embodiments, enriched entity behavior information may be provided by the enrichment module **506** to a streaming **508** analytics module. In turn, the streaming **508** analytics module may provide some or all of the enriched entity behavior information to an on-demand **510** analytics module. As used herein, streaming **408** analytics broadly refers to analytics performed in near real-time on enriched entity behavior information as it is received. Likewise, on-demand **510** analytics broadly refers herein to analytics performed, as they are requested, on enriched entity behavior information after it has been received. In certain embodiments, the enriched entity behavior information may be associated with a particular event. In certain embodiments, the enrichment **506** and streaming analytics **508** modules may be implemented to perform event queue analytics **504** operations, as described in greater detail herein.

In certain embodiments, the on-demand **510** analytics may be performed on enriched entity behavior associated with a particular interval of, or point in, time. In certain embodiments, the streaming **508** or on-demand **510** analytics may be performed on enriched entity behavior associated with a particular user, group of users, one or more non-user entities, or a combination thereof. In certain embodiments, the streaming **408** or on-demand **510** analytics may be performed on enriched entity behavior associated with a particular resource, such as a facility, system, datastore, or service. Those of skill in the art will recognize that many such embodiments are possible. Accordingly, the foregoing is not intended to limit the spirit, scope or intent of the invention.

In certain embodiments, the results of various analytics operations performed by the streaming **508** or on-demand **510** analytics modules may be provided to a storage Application Program Interface (API) **514**. In turn, the storage API **512** may be implemented to provide access to certain data sources **520**, such as datastores '1' **516** through 'n' **518**. In certain embodiments, the datastores '1' **516** through 'n' **518** may variously include a datastore of entity identifiers, temporal events, or a combination thereof. In certain embodi-

ments, the storage API **512** may be implemented to provide access to repositories of event **512**, entity behavior catalog (EBC) **540**, security analytics **550**, and security risk scoring **560** data, or a combination thereof. In various embodiments, the data stores '1' **516** through 'n' **518** may be implemented to store the results of certain security analytics operations.

In certain embodiments, the security analytics system **118** may be implemented with a logging and reporting front-end **512**, which is used to receive the results of analytics operations performed by the streaming **508** analytics module. In certain embodiments, the security analytics system **118** may be implemented to include an entity behavior catalog system **120**, or a human factors framework **122**, or both. In certain embodiments, the human factors framework **122** may be implemented to receive human factors information, described in greater detail herein, from a human factors data collector **522**. In various embodiments, the entity behavior catalog system **120** and the human factors framework **122** may respectively be implemented to use the storage API **514** to access certain data stored in the data sources **520**, the repositories of event **530**, entity behavior catalog (EBC) **540**, security analytics **550**, and security risk scoring **560** data, or a combination thereof.

In certain embodiments, the security analytics system **118** may include a risk scoring system **124** implemented to perform risk scoring operations, described in greater detail herein. In certain embodiments, functionalities of the risk scoring system **124** may be provided in the form of a risk management service **524**. In various embodiments, the risk management service **524** may be implemented to perform certain operations associated with defining and managing an entity behavior profile (EBP), as described in greater detail herein. In certain embodiments, the risk management service **524** may be implemented to perform operations associated with detecting entity behavior that may be of analytic utility and adaptively responding to mitigate risk, as described in greater detail herein.

In certain embodiments, the risk management service **524** may be implemented to provide the results of various analytics operations performed by the streaming **506** or on-demand **508** analytics modules. In certain embodiments, the risk management service **524** may be implemented to use the storage API **514** to access various enhanced cyber behavior and analytics information stored on the data sources **520**, the repositories of event **530**, EBC **540**, security analytics **550**, and security risk scoring **560** data, or a combination thereof. Skilled practitioners of the art will recognize that many such embodiments are possible. Accordingly, the foregoing is not intended to limit the spirit, scope or intent of the invention.

FIG. 6 shows a simplified block diagram of an entity behavior profile (EBP) implemented in accordance with an embodiment of the invention. In certain embodiments, a security analytics system **118**, described in greater detail herein, may be implemented to include an entity behavior catalog (EBC) system **120**, a human factors framework **122**, and a security risk scoring system **124**, or a combination thereof. In certain embodiments, the security analytics system **118** may be implemented to access a repository of event **530**, EBC **540**, security analytics **550**, and security risk scoring **560** data, or a combination thereof. In various embodiments, the security analytics system **118** may be implemented to use certain information stored in the repository of event **530**, EBC **540**, security analytics **550**, and security risk scoring **560** data, or a combination thereof, to perform a security analytics operation, described in greater detail herein. In certain embodiments, the results of a

particular security analytics operation may be stored in the repository of security analytics **550** data.

In certain embodiments, the EBC system **120** may be implemented to generate, manage, store, or some combination thereof, information related to the behavior of an associated entity. In certain embodiments, the information related to the behavior of a particular entity may be stored in the form of an entity behavior profile (EBP) **420**. In certain embodiments, the EBC system **120** may be implemented to store the information related to the behavior of a particular entity in the repository of EBC **540** data. In various embodiments, the EBC system **120** may be implemented to generate certain information related to the behavior of a particular entity from event information associated with the entity, as described in greater detail herein. In certain embodiments, event information associated with a particular entity may be stored in the repository of event **530** data.

In various embodiments, the EBC system **120** may be implemented as a cyber behavior catalog. In certain of these embodiments, the cyber behavior catalog may be implemented to generate, manage, store, or some combination thereof, information related to cyber behavior, described in greater detail herein, enacted by an associated entity. In various embodiments, as likewise described in greater detail herein, the information generated, managed, stored, or some combination thereof, by such a cyber behavior catalog may be related to cyber behavior enacted by a user entity, a non-user entity, or a data entity, or a combination thereof.

In various embodiments, the EBC system **120** may be implemented to perform EBP **420** management operations to process certain entity behavior information, described in greater detail herein, and entity attribute information associated with defining and managing an EBP **420**. As used herein, entity attribute information broadly refers to information associated with a particular entity that can be used to uniquely identify the entity, and describe certain associated properties, or a combination thereof. In various embodiments, the entity attribute information may include certain types of content. In certain embodiments, such content may include text, unstructured data, structured data, graphical images, photographs, audio recordings, video recordings, biometric information, and so forth. In certain embodiments, the entity attribute information may include metadata. In certain embodiments, the metadata may include entity attributes, which in turn may include certain entity identifier types or classifications.

In certain embodiments, the entity attribute information may include entity identifier information. In various embodiments, the EBC system **120** may be implemented to use certain entity identifier information to ascertain the identity of an associated entity at a particular point in time. As used herein, entity identifier information broadly refers to an information element associated with an entity that can be used to ascertain or corroborate the identity of its corresponding entity at a particular point in time. In various embodiments, the entity identifier information may include certain user entity **422**, non-user entity **440**, and data **450** entity profile attributes, or a combination thereof.

In certain embodiments, the entity identifier information may include temporal information, described in greater detail herein. In various embodiments, the security analytics system **118** may be implemented to use certain aspects of the EBC system **120** and such temporal information to assess the risk associated with a particular entity, at a particular point in time, and respond with a corresponding security operation, likewise described in greater detail herein. In

certain embodiments, the security analytics system **118** may be implemented to respond to such assessments in order to reduce operational overhead and improve system efficiency while maintaining associated security and integrity. In certain embodiments, the response to such assessments may be performed by a security administrator. Accordingly, certain embodiments of the invention may be directed towards assessing the risk associated with the affirmative resolution of the identity of an entity at a particular point in time in combination with its behavior and associated contextual information, such as human factors **430** information, described in greater detail herein. Consequently, the EBC system **120** may be more oriented in various embodiments to risk adaptation than to security administration.

In certain embodiments, an EBP **420** may be implemented to include a user entity profile **422**, a non-user entity profile **440**, a data entity profile **450**, one or more entity risk scores **460**, one or more entity states **462**, and one or more entity behavior models **464**, or a combination thereof. In various embodiments, the user entity profile **422** may include user profile attributes **604**, user behavior factors **610**, user mindset factors **622**, certain human factors **430**, and a user entity mindset profile **632**, or a combination thereof. In various embodiments, the user profile attributes **604** may include certain user authentication factors **606**, described in greater detail herein, and personal information **608**.

As used herein, a user profile attribute **604** broadly refers to data or metadata that can be used, individually or in combination with other user profile attributes **604**, user behavior factors **610**, or user mindset factors **622**, to ascertain the identity of a user entity. In various embodiments, certain user profile attributes **604** may be uniquely associated with a particular user entity. In certain embodiments, the personal information **608** may include non-sensitive personal information associated with a user entity, such as their name, title, position, role, and responsibilities.

In certain embodiments, the personal information **608** may likewise include technical skill level information, peer information, expense account information, paid time off (PTO) information, data analysis information, insider information, misconfiguration information, third party information, or a combination thereof. In certain embodiments, the personal information **608** may contain sensitive personal information associated with a user entity. As used herein, sensitive personal information (SPI), also commonly referred to as personally identifiable information (PII), broadly refers to any information usable to ascertain the identity of a user entity, either by itself, or in combination with other information, such as contextual information described in greater detail herein.

Examples of SPI may include the full or legal name of a user entity, initials or nicknames, place and date of birth, home and business addresses, personal and business telephone numbers, their gender, and other genetic information. Additional examples of SPI may include government-issued identifiers, such as a Social Security Number (SSN) or a passport number, vehicle registration plate and serial numbers, and driver's license numbers. Other examples of SPI may include certain email addresses and social media identifiers, credit and debit card numbers, and other digital identity information. Yet other examples of SPI may include employer-issued identifiers, financial transaction information, credit scores, electronic medical records (EMRs), insurance claim information, personal correspondence, and so forth. Further examples of SPI may include user authentication factors **606**, such as biometrics, user identifiers and passwords, and personal identification numbers (PINs). In

certain embodiments, the SPI may include information considered by an individual user, a group of users, or an organization (e.g., a company, a government or non-government organization, etc.), to be confidential or proprietary.

As used herein, a user behavior factor **610** broadly refers to information associated with a user entity's behavior, whether the behavior occurs within a physical realm or cyberspace. In certain embodiments, user behavior factors **610** may include the user entity's access rights **612**, the user entity's interactions **614**, and the date/time/frequency **616** of when the interactions **614** are enacted. In certain embodiments, the user behavior factors **610** may likewise include the user entity's location **618**, and the gestures **620** used by the user entity to enact the interactions **614**.

In certain embodiments, the user entity gestures **620** may include key strokes on a keypad, a cursor movement, a mouse movement or click, a finger swipe, tap, or other hand gesture, an eye movement, or some combination thereof. In certain embodiments, the user entity gestures **620** may likewise include the cadence of the user's keystrokes, the motion, force and duration of a hand or finger gesture, the rapidity and direction of various eye movements, or some combination thereof. In certain embodiments, the user entity gestures **620** may include various audio or verbal commands performed by the user.

As used herein, user mindset factors **622** broadly refer to information used to make inferences regarding the mental state of a user entity at a particular point in time, during the occurrence of an event or an enactment of a user behavior, or a combination thereof. As likewise used herein, mental state broadly refers to a hypothetical state corresponding to the way a user entity may be thinking or feeling. In certain embodiments, the user entity mindset factors **622** may include a personality type **624**. Examples of known approaches for determining a personality type **624** include Jungian types, Myers-Briggs type indicators, Keirsey Temperament Sorter, Socionics, Enneagram of Personality, and Eysenck's three-factor model.

In certain embodiments, the user mindset factors **622** may include various behavioral biometrics **626**. As used herein, a behavioral biometric **628** broadly refers to a physiological indication of a user entity's mental state. Examples of behavioral biometrics **626** may include a user entity's blood pressure, heart rate, respiratory rate, eye movements and iris dilation, facial expressions, body language, tone and pitch of voice, speech patterns, and so forth.

Certain embodiments of the invention reflect an appreciation that certain user behavior factors **610**, such as user entity gestures **620**, may provide additional information related to inferring a user entity's mental state. As an example, a user entering text at a quick pace with a rhythmic cadence may indicate intense focus. Likewise, an individual user intermittently entering text with forceful keystrokes may indicate the user is in an agitated state. As another example, the user may intermittently enter text somewhat languorously, which may indicate being in a thoughtful or reflective state of mind. As yet another example, the user may enter text with a light touch with an uneven cadence, which may indicate the user is hesitant or unsure of what is being entered.

Certain embodiments of the invention likewise reflect an appreciation that while the user entity gestures **620** may provide certain indications of the mental state of a particular user entity, they may not provide the reason for the user entity to be in a particular mental state. Likewise, certain embodiments of the invention include an appreciation that certain user entity gestures **620** and behavioral biometrics

626 are reflective of an individual user's personality type 624. As an example, aggressive, forceful keystrokes combined with an increased heart rate may indicate normal behavior for a particular user when composing end-of-month performance reviews. In various embodiments, certain user entity behavior factors 610, such as user gestures 620, may be correlated with certain contextual information, as described in greater detail herein.

In various embodiments, the EBC system 120 may be implemented to use certain human factors 430, described in greater detail herein, in combination with other information contained in the user entity profile 422, and a particular entity state 462, described in greater detail herein, to generate an associated user entity mindset profile 632. As used herein, a user entity mindset profile 632 broadly refers to a collection of information that reflects an inferred mental state of a user entity at a particular time during the occurrence of an event, an enactment of an associated user entity behavior, or a combination of the two. As an example, certain information may be known about a user entity, such as their name, their title and position, and so forth, all of which are user profile attributes 604. Likewise, it may be possible to observe a user entity's associated user behavior factors 610, such as their interactions with various systems, when they log-in and log-out, when they are active at the keyboard, the rhythm of their keystrokes, and which files they typically use.

Certain embodiments of the invention reflect an appreciation these user behavior factors 610 may change, a little or a lot, from day to day. These changes may be benign, such as when a user entity begins a new project and accesses new data, or they may indicate something more concerning, such as a user entity who is actively preparing to steal data from their employer. In certain embodiments, the user behavior factors 610 may be implemented to ascertain the identity of a user entity. In certain embodiments, the user behavior factors 610 may be uniquely associated with a particular user entity.

In certain embodiments, observed user entity behaviors may be used to build a user entity profile 422 for a particular user entity. In addition to creating a model of a user entity's various attributes and observed behaviors, these observations can likewise be used to infer things that are not necessarily explicit. Accordingly, in certain embodiments, observed user entity behaviors may be used in combination with an EBP 420 to generate an inference regarding an associated user entity. As an example, a particular user may be observed eating a meal, which may or may not indicate the user is hungry. However, if it is also known that the user worked at their desk throughout lunchtime and is now eating a snack during a mid-afternoon break, then it can be inferred they are indeed hungry that afternoon.

In various embodiments, the non-user entity profile 440 may be implemented to include certain non-user entity profile attributes 642. As used herein, a non-user profile attribute 642 broadly refers to data or metadata that can be used, individually or in combination with other non-user entity profile attributes 642, to ascertain the identity of a non-user entity. In various embodiments, certain non-user entity profile attributes 642 may be uniquely associated with a particular non-user entity, described in greater detail herein.

In certain embodiments, the non-user profile attributes 642 may be implemented to include certain identity information, such as a non-user entity's associated network, Media Access Control (MAC), physical address, serial number, associated configuration information, and so forth. In

various embodiments, the non-user profile attributes 642 may be implemented to include non-user entity behavior information associated with interactions between certain user entities, non-user entities, and data entities, the type of those interactions, the data exchanged during the interactions, the date/time/frequency of such interactions, and certain services accessed or provided.

In various embodiments, the data entity profile 450 may be implemented to include certain data profile attributes 652. As used herein, a data profile attribute broadly refers to data or metadata that can be used, individually or in combination with other data profile attributes 652, to ascertain the identity of a data entity. In various embodiments, certain data profile attributes 652 may be uniquely associated with a particular data entity, described in greater detail herein.

In certain embodiments, the data profile attributes 652 may be implemented to include certain identity information, such as a file name, a hash value, time and date stamps, size and type of the data (e.g., structured, binary, etc.), a digital watermark familiar to those of skill in the art, and so forth. In various embodiments, the data entity profile attributes 652 may be implemented to include data behavior information associated with entity interactions between the data entity and certain user and non-user entities, the type of those interactions, modifications to data during a particular interaction, and the date/time/frequency of such interactions.

In various embodiments, the EBC system 120 may be implemented to use certain data associated with an EBP 420 to provide a probabilistic measure of whether a particular electronically-observable event is of analytic utility. As used herein, an event of analytic utility broadly refers to any information associated with a particular event deemed to be relevant in the performance of a security analytics operation, described in greater detail herein. In certain embodiments, an electronically-observable event that is of analytic utility may be determined to be anomalous, abnormal, unexpected, or suspicious. In certain embodiments, an electronically-observable event determined to be anomalous, abnormal, unexpected, or suspicious may be associated with an operation performed by a particular entity that is likewise considered to be concerning, as described in greater detail herein.

To continue the prior example, a user may typically work out of their company's corporate office on Fridays. Furthermore, various user mindset factors 622 within their associated user entity profile 422 may indicate that the user is typically relaxed and methodical when working with customer data. Moreover, the user's associated user entity profile 422 indicates that such user interactions 614 with customer data typically occur on Monday mornings and the user rarely, if ever, copies or downloads customer data. However, the user may decide to interact with certain customer data late at night, on a Friday, while in their company's corporate office. As they do so, they exhibit an increased heart rate, rapid breathing, and furtive keystrokes while downloading a subset of customer data to a flash drive.

Consequently, their user entity mindset profile 632 may reflect a nervous, fearful, or guilty mindset, which is inconsistent with the entity state 462 of dealing with customer data in general. More particularly, downloading customer data late at night on a day the user is generally not in their primary office results in an entity state 462 that is likewise inconsistent with the user's typical user behavior. As a result, the EBC system 120 may infer that the user's behavior may represent a security threat. Those of skill in the art will recognize that many such embodiments and

examples are possible. Accordingly, the foregoing is not intended to limit the spirit, scope or intent of the invention.

Certain embodiments of the invention reflect an appreciation that the quantity, and relevancy, of information contained in a particular EBP 420 may have a direct bearing on its analytic utility when attempting to determine the trustworthiness of an associated entity and whether or not they represent a security risk. As used herein, the quantity of information contained in a particular EBP 420 broadly refers to the variety and volume of EBP elements it may contain, and the frequency of their respective instances, or occurrences, related to certain aspects of an associated entity's identity and behavior. As likewise used herein, information of analytic utility contained in an EBP 420 broadly refers to any information deemed to be relevant in the performance of a security analytics operation, described in greater detail herein. Likewise, as used herein, an EBP element broadly refers to any data element stored in an EBP 420, as described in greater detail herein. In various embodiments, an EBP element may be used to describe a particular aspect of an EBP, such as certain user profile attributes 604, user behavior factors 610, user mindset factors 622, user entity mindset profile 632, non-user entity profile attributes 642, data entity profile attributes 652, an entity risk score 460, an entity state 462, and an entity behavior model 464.

In certain embodiments, statistical analysis may be performed on the information contained in a particular EBP 420 to determine the trustworthiness of its associated entity and whether or not they represent a security risk. For example, a particular authentication factor 606, such as a biometric, may be consistently used by a user entity for authenticating their identity to their endpoint device. To continue the example, a user ID and password may be used by the same, or a different user entity, in an attempt to access the endpoint device. As a result, the use of a user ID and password may indicate a security risk due to its statistical infrequency. As another example, a user entity may consistently access three different systems on a daily basis in their role as a procurement agent. In this example, the three systems may include a financial accounting system, a procurement system, and an inventory control system. To continue the example, an attempt by the procurement agent to access a sales forecast system may appear suspicious if never attempted before, even if the purpose for accessing the system is legitimate.

As likewise used herein, the relevancy of information contained in a particular EBP 420 broadly refers to the pertinence of the EBP elements it may contain to certain aspects of an associated entity's identity and behavior. To continue the prior example, an EBP 420 associated with the procurement agent may contain certain user profile attributes 604 related to their title, position, role, and responsibilities, all or which may be pertinent to whether or not they have a legitimate need to access the sales forecast system. In certain embodiments, the user profile attributes 604 may be implemented to include certain job description information. To further continue the example, such job description information may have relevance when attempting to determine whether or not the associated entity's behavior is suspicious. In further continuance of the example, job description information related to the procurement agent may include their responsibility to check sales forecast data, as needed, to ascertain whether or not to procure certain items. In these embodiments, the method by which it is determined whether the information contained in a particular EBP 420 is of sufficient quantity and relevancy is a matter of design choice.

Various embodiments of the invention likewise reflect an appreciation that accumulating sufficient information in an EBP 420 to make such a determination may take a certain amount of time. Likewise, various embodiments of the invention reflect an appreciation that the effectiveness or accuracy of such a determination may rely upon certain entity behaviors occurring with sufficient frequency, or in identifiable patterns, or a combination thereof, during a particular period of time. As an example, there may not be sufficient occurrences of a particular type of entity behavior to determine if a new entity behavior is inconsistent with known past occurrences of the same type of entity behavior. Accordingly, various embodiments of the invention reflect an appreciation that a sparsely-populated EBP 420 may result in exposure to certain security vulnerabilities.

In certain embodiments, the human factors framework 122 may be implemented to perform a human factors risk operation, likewise described in greater detail herein. In various embodiments, as likewise described in greater detail herein, the human factors framework 122 may be implemented to use certain event information stored in the repositories of event 530, EBC 540, security analytics 550, and security risk scoring 560 data, or a combination thereof, to perform the human factors risk operation. In certain embodiments, the human factors risk operation may be performed to assess the risk of an event associated with a particular user entity.

FIG. 7 is a simplified Venn diagram showing entity interactions implemented in accordance with an embodiment of the invention between a user entity, a non-user entity, and a data entity. As shown in FIG. 7, entity interactions 702, described in greater detail herein, may occur in certain embodiments between a user entity 704, a non-user entity 706, or a data entity 708. Likewise, entity interactions 702 may respectively occur in certain embodiments between a user entity 704, a non-user entity 706, or a data entity 708 and other user entities 714, other non-user entities 716, or other data entities 718. Skilled practitioners of the art will recognize that many such examples of entity interactions 702 are possible. Accordingly, the foregoing is not intended to limit the spirit, scope, or intent of the invention.

FIG. 8 shows the enactment of entity interactions implemented in accordance with embodiment of the invention between user entities, non-user entities, and data entities. In various embodiments, a user entity-to-user entity 820 interaction may occur between a first user entity, such as user entity 'A' 810, and a second user entity, such as user entity 'B' 812. In various embodiments, a user entity-to-non-user entity 830 interaction may occur between a user entity, such as user entity 'A' 810 and certain non-user entities 804, described in greater detail herein. In various embodiments, a user entity-to-data entity 840 interaction may occur between a user entity, such as user entity 'A' 810, and certain data entities 806. In various embodiments, a non-user entity-to-data entity 850 interaction may occur between certain non-user entities 804 and certain data entities 806.

In various embodiments, certain information associated with user entity-to-user entity 820, user entity-to-non-user entity 830, and user entity-to-data entity 840 interactions may be stored within a user entity profile 420, described in greater detail herein. In various embodiments, such information stored in the user entity profile 422 may include certain attribute 422, behavior 426, and inference 430, or a combination thereof, as likewise described in greater detail herein. Those of skill in the art will recognize that many such embodiments are possible. Accordingly, the foregoing is not intended to limit the spirit, scope, or intent of the invention.

FIGS. 9a and 9b show a block diagram of a security analytics environment implemented in accordance with an embodiment of the invention. In certain embodiments, a security analytics system 118 may be implemented with an entity behavior catalog (EBC) system 120, a human factors framework 122, and a security risk scoring system 124, or a combination thereof. In certain embodiments, analyses performed by the security analytics system 118 may be used to identify behavior associated with a particular entity that may be of analytic utility.

In certain embodiments, as likewise described in greater detail herein, the EBC system 120, the human factors framework 122, and the security risk scoring system 124, or a combination thereof, may be used in combination with the security analytics system 118 to perform such analyses. In various embodiments, certain data stored in repositories of event 530, EBC catalog 540, security analytics 550, and security risk scoring 560 data, or a combination thereof, may be used by the security analytics system 118 to perform the analyses. As likewise described in greater detail herein, the security analytics system 118, the EBC system 120, the human factors framework 122, and the security risk scoring system 124, or a combination thereof, may be used in combination with one another in certain embodiments to perform a human factors risk operation. Likewise, certain data stored in the repositories of event 530, EBC catalog 540, security analytics 550, and security risk scoring 560 data, or a combination thereof, may be used in various embodiments to perform the human factors risk operation.

In certain embodiments, a user entity may be an individual user, such as user 'A' 710 or 'B' 712, a group, an organization, or a government. In certain embodiments, a non-user entity may likewise be an item, or a device, such as endpoint 204 and edge 304 devices, or a network, such as a network 140 or third party network 310. In certain embodiments, a non-user entity may be a resource 950, such as a geographical location or formation, a physical facility 952, such as a venue, various physical security devices 954, a system 956, shared devices 958, such as printer, scanner, or copier, a data store 960, or a service 962, such as a service 962 operating in a cloud environment. In various embodiments, the data entity may be certain data 934 stored on an endpoint device 204, such as a data element, a data file, or a data store known to those of skill in the art.

In various embodiments, certain user authentication factors 606 may be used to authenticate the identity of a user entity. In certain embodiments, the user authentication factors 606 may be used to ensure that a particular user entity, such as user 'A' 710 or 'B' 712, is associated with their corresponding user entity profile 422, rather than a user entity profile 422 associated with another user. In certain embodiments, the user authentication factors 606 may include a user's biometrics 906 (e.g., a fingerprint or retinal scan), tokens 908 (e.g., a dongle containing cryptographic keys), user identifiers and passwords (ID/PW) 910, and personal identification numbers (PINs).

In certain embodiments, information associated with such user entity behavior may be stored in a user entity profile 422, described in greater detail herein. In certain embodiments, the user entity profile 422 may be stored in a repository of entity behavior catalog (EBC) data 440. In various embodiments, as likewise described in greater detail herein, the user entity profile 422 may include user profile attributes 604, user behavior factors 610, user mindset factors 622, certain human factors 430, and a user mindset profile 632, or a combination thereof. As used herein, a user profile attribute 604 broadly refers to data or metadata that

can be used, individually or in combination with other user profile attributes 604, user behavior factors 610, or user mindset factors 622, to ascertain the identity of a user entity. In various embodiments, certain user profile attributes 604 may be uniquely associated with a particular user entity.

As likewise used herein, a user behavior factor 610 broadly refers to information associated with a user's behavior, whether the behavior occurs within a physical realm or cyberspace. In certain embodiments, the user behavior factors 610 may include the user's access rights 612, the user's interactions 614, and the date/time/frequency 616 of those interactions 614. In certain embodiments, the user behavior factors 610 may likewise include the user's location 618 when the interactions 614 are enacted, and the user gestures 620 used to enact the interactions 614.

In various embodiments, certain date/time/frequency 616 user behavior factors 610 may be implemented as ontological or societal time, or a combination thereof. As used herein, ontological time broadly refers to how one instant in time relates to another in a chronological sense. As an example, a first user behavior enacted at 12:00 noon on May 17, 2017 may occur prior to a second user behavior enacted at 6:39 PM on May 18, 2018. Skilled practitioners of the art will recognize one value of ontological time is to determine the order in which various entity behaviors have been enacted.

As likewise used herein, societal time broadly refers to the correlation of certain user profile attributes 604, user behavior factors 610, user mindset factors 622, or a combination thereof, to one or more instants in time. As an example, user 'A' 710 may access a particular system 956 to download a customer list at 3:47 PM on Nov. 3, 2017. Analysis of their entity behavior profile indicates that it is not unusual for user 'A' 710 to download the customer list on a weekly basis. However, examination of their user behavior profile also indicates that user 'A' 710 forwarded the downloaded customer list in an email message to user 'B' 712 at 3:49 PM that same day. Furthermore, there is no record in their associated entity behavior profile that user 'A' 710 has ever communicated with user 'B' 712 in the past. Moreover, it may be determined that user 'B' 712 is employed by a competitor. Accordingly, the correlation of user 'A' 710 downloading the customer list at one point in time, and then forwarding the customer list to user 'B' 712 at a second point in time shortly thereafter, is an example of societal time.

In a variation of the prior example, user 'A' 710 may download the customer list at 3:47 PM on Nov. 3, 2017. However, instead of immediately forwarding the customer list to user 'B' 712, user 'A' 710 leaves for a two week vacation. Upon their return, they forward the previously-downloaded customer list to user 'B' 712 at 9:14 AM on Nov. 20, 2017. From an ontological time perspective, it has been two weeks since user 'A' 710 accessed the system 956 to download the customer list. However, from a societal time perspective, they have still forwarded the customer list to user 'B' 712, despite two weeks having elapsed since the customer list was originally downloaded.

Accordingly, the correlation of user 'A' 710 downloading the customer list at one point in time, and then forwarding the customer list to user 'B' 712 at a much later point in time, is another example of societal time. More particularly, it may be inferred that the intent of user 'A' 710 did not change during the two weeks they were on vacation. Furthermore, user 'A' 710 may have attempted to mask an intended malicious act by letting some period of time elapse between the time they originally downloaded the customer list and when they eventually forwarded it to user 'B' 712. From the

foregoing, those of skill in the art will recognize that the use of societal time may be advantageous in determining whether a particular entity behavior is of analytic utility. As used herein, mindset factors **622** broadly refer to information used to infer the mental state of a user entity at a particular point in time, during the occurrence of an event, an enactment of a user entity behavior, or combination thereof.

In certain embodiments, the security analytics system **118** may be implemented to process certain entity attribute information, described in greater detail herein, associated with providing resolution of the identity of an entity at a particular point in time. In various embodiments, the security analytics system **118** may be implemented to use certain entity identifier information, likewise described in greater detail herein, to ascertain the identity of an associated entity at a particular point in time. In various embodiments, the entity identifier information may include certain temporal information, described in greater detail herein. In certain embodiments, the temporal information may be associated with an event associated with a particular point in time.

In certain embodiments, the security analytics system **118** may be implemented to use information associated with certain entity behavior elements to resolve the identity of an entity at a particular point in time. An entity behavior element, as used herein, broadly refers to a discrete element of an entity's behavior during the performance of a particular action, or operation, in a physical realm, cyberspace, or a combination thereof. In certain embodiments, such entity behavior elements may be associated with a user/device **930**, a user/network **942**, a user/resource **948**, a user/user **920** interaction, or a combination thereof. In certain embodiments, a user/device **930**, user/network **942**, and user/resource **948** interactions are all examples of a user entity-to-non-user entity interaction, described in greater detail herein. In certain embodiments, a user/user **920** interaction is one example of a user entity-to-user entity interaction, likewise described in greater detail herein.

As an example, user 'A' **710** may use an endpoint device **204** to browse a particular web page on a news site on an external system **976**. In this example, the individual actions performed by user 'A' **710** to access the web page are entity behavior elements that constitute an entity behavior, described in greater detail herein. As another example, user 'A' **710** may use an endpoint device **204** to download a data file from a particular system **956**. In this example, the individual actions performed by user 'A' **710** to download the data file, including the use of one or more user authentication factors **606** for user authentication, are entity behavior elements that constitute an entity behavior. In certain embodiments, the user/device **930** interactions may include an interaction between a user, such as user 'A' **710** or 'B' **712**, and an endpoint device **204**.

In certain embodiments, the user/device **930** interaction may include interaction with an endpoint device **204** that is not connected to a network at the time the interaction occurs. As an example, user 'A' **710** or 'B' **712** may interact with an endpoint device **204** that is offline, using applications **932**, accessing data **934**, or a combination thereof, it may contain. Those user/device **930** interactions, or their result, may be stored on the endpoint device **204** and then be accessed or retrieved at a later time once the endpoint device **204** is connected to the network **140** or third party networks **310**. In certain embodiments, an endpoint agent **206** may be implemented to store the user/device **930** interactions when the user device **204** is offline.

In certain embodiments, an endpoint device **24** may be implemented with a device camera **928**. In certain embodiments, the device camera **928** may be integrated into the endpoint device **204**. In certain embodiments, the device camera **928** may be implemented as a separate device configured to interoperate with the endpoint device **204**. As an example, a webcam familiar to those of skill in the art may be implemented receive and communicate various image and audio signals to an endpoint device **204** via a Universal Serial Bus (USB) interface.

In certain embodiments, the device camera **928** may be implemented to capture and provide user/device **930** interaction information to an endpoint agent **206**. In various embodiments, the device camera **928** may be implemented to provide surveillance information related to certain user/device **930** or user/user **920** interactions. In certain embodiments, the surveillance information may be used by the security analytics system **118** to detect entity behavior associated with a user entity, such as user 'A' **710** or user 'B' **712**, that may be of analytic utility.

In certain embodiments, the endpoint device **204** may be used to communicate data through the use of a network **140**, a third party network **310**, or a combination thereof. In certain embodiments, the network **140** and the third party networks **310** may respectively include a public network, such as the Internet, a physical private network, a virtual private network (VPN), or any combination thereof. In certain embodiments, the network **140** and third party networks **310** may likewise include a wireless network, including a personal area network (PAN), based upon technologies such as Bluetooth. In various embodiments, the wireless network may include a wireless local area network (WLAN), based on variations of the IEEE 802.11 specification, commonly referred to as WiFi. In certain embodiments, the wireless network may include a wireless wide area network (WWAN) based on an industry standard including various 3G, 4G, and 5G technologies.

In certain embodiments, the user/user **920** interactions may include interactions between two or more user entities, such as user 'A' **710** and 'B' **712**. In certain embodiments, the user/user interactions **920** may be physical, such as a face-to-face meeting, via a user/device **930** interaction, a user/network **942** interaction, a user/resource **948** interaction, or some combination thereof. In certain embodiments, the user/user **920** interaction may include a face-to-face verbal exchange. In certain embodiments, the user/user **920** interaction may include a written exchange, such as text written on a sheet of paper. In certain embodiments, the user/user **920** interaction may include a face-to-face exchange of gestures, such as a sign language exchange.

In certain embodiments, temporal event information associated with various user/device **930**, user/network **942**, user/resource **948**, or user/user **920** interactions may be collected and used to provide real-time resolution of the identity of an entity at a particular point in time. Those of skill in the art will recognize that many such examples of user/device **930**, user/network **942**, user/resource **948**, and user/user **920** interactions are possible. Accordingly, the foregoing is not intended to limit the spirit, scope or intent of the invention.

In various embodiments, the security analytics system **118** may be implemented to process certain contextual information in the performance of a particular security analytic operation. As used herein, contextual information broadly refers to any information, directly or indirectly, individually or in combination, related to a particular entity behavior. In certain embodiments, entity behavior may include a user entity's physical behavior, cyber behavior, or a combination

thereof. As likewise used herein, a user entity's physical behavior broadly refers to any user behavior occurring within a physical realm, such as speaking, gesturing, facial patterns or expressions, walking, and so forth. More particularly, such physical behavior may include any action enacted by an entity user that can be objectively observed, or indirectly inferred, within a physical realm. In certain embodiments, the objective observation, or indirect inference, of the physical behavior may be performed electronically.

As an example, a user may attempt to use an electronic access card to enter a secured building at a certain time. In this example, the use of the access card to enter the building is the action and the reading of the access card makes the user's physical behavior electronically-observable. As another example, a first user may physically transfer a document to a second user, which is captured by a video surveillance system. In this example, the physical transfer of the document from the first user to the second user is the action. Likewise, the video record of the transferal makes the first and second user's physical behavior electronically-observable. As used herein, electronically-observable user behavior broadly refers to any behavior exhibited or enacted by a user entity that can be observed through the use of an electronic device (e.g., an electronic sensor), a computing device or system (e.g., an endpoint **204** or edge **304** device, a physical security device **954**, a system **956**, a shared device **958**, etc.), computer instructions (e.g., a software application), or a combination thereof.

In certain embodiments, the contextual information may include location data **936**. In certain embodiments, the endpoint device **204** may be configured to receive such location data **936**, which is used as a data source for determining the user's location **618**. In certain embodiments, the location data **936** may include Global Positioning System (GPS) data provided by a GPS satellite **938**. In certain embodiments, the location data **936** may include location data **936** provided by a wireless network, such as from a cellular network tower **940**. In certain embodiments (not shown), the location data **936** may include various Internet Protocol (IP) or other network address information assigned to the endpoint **204** or edge **304** device. In certain embodiments (also not shown), the location data **936** may include recognizable structures or physical addresses within a digital image or video recording.

In certain embodiments, the endpoint devices **204** may include an input device (not shown), such as a keypad, magnetic card reader, token interface, biometric sensor, and so forth. In certain embodiments, such endpoint devices **204** may be directly, or indirectly, connected to a particular facility **952**, physical security device **954**, system **956**, or shared device **958**. As an example, the endpoint device **204** may be directly connected to an ingress/egress system, such as an electronic lock on a door or an access gate of a parking garage. As another example, the endpoint device **204** may be indirectly connected to a physical security device **954** through a dedicated security network (not shown).

In certain embodiments, the security analytics system **118** may be implemented to perform various risk-adaptive protection operations. Risk-adaptive, as used herein, broadly refers to adaptively responding to risks associated with an electronically-observable entity behavior. In various embodiments, the security analytics system **118** may be implemented to perform certain risk-adaptive protection operations by monitoring individual entity behaviors, assess the corresponding risk they may represent, individually or in combination, and respond with an associated response. In

certain embodiments, such responses may be based upon contextual information, described in greater detail herein, associated with a particular entity behavior.

In certain embodiments, certain information associated with a user entity profile **420**, likewise described in greater detail herein, may be used to perform the risk-adaptive protection operations. In certain embodiments, the user entity profile **422** may include user profile attributes **604**, user behavior factors **610**, user mindset factors **622**, or a combination thereof. In these embodiments, the information associated with a user entity profile **422** used to perform the risk-adaptive protection operations is a matter of design choice.

In certain embodiments, the security analytics system **118** may be implemented as a stand-alone system. In certain embodiments, the security analytics system **118** may be implemented as a distributed system. In certain embodiment, the security analytics system **118** may be implemented as a virtual system, such as an instantiation of one or more virtual machines (VMs). In certain embodiments, the security analytics system **118** may be implemented as a security analytics service **308**. In certain embodiments, the security analytics service **308** may be implemented in a cloud environment familiar to those of skill in the art. In various embodiments, the security analytics system **118** may use data stored in a repository of event **430**, entity behavior catalog **440**, security analytics **450**, or security risk **460** data, or a combination thereof, in the performance of certain security analytics operations, described in greater detail herein. Those of skill in the art will recognize that many such embodiments are possible. Accordingly, the foregoing is not intended to limit the spirit, scope or intent of the invention.

FIG. **10** is a simplified block diagram showing the mapping of an event to a security vulnerability scenario implemented in accordance with an embodiment of the invention. In certain embodiments, an entity behavior catalog (EBC) system may be implemented to identify an indicator of behavior (IOB), described in greater detail herein. In certain embodiments, the IOB may be based upon one or more observables, likewise described in greater detail herein. In certain embodiments, the observable may include event information corresponding to electronically-observable behavior enacted by an entity. In certain embodiments, the event information corresponding to electronically-observable behavior enacted by an entity may be received from an electronic data source, such as the event data sources **1010** shown in FIG. **10**.

In certain embodiments, as likewise described in greater detail herein, the EBC system may be implemented to identify a particular event of analytic utility by analyzing an associated IOB. In certain embodiments, the EBC system may be implemented to generate entity behavior catalog data based upon an identified event of analytic utility associated with a particular IOB. In various embodiments, the EBC system may be implemented to associate certain entity behavior data it may generate with a predetermined abstraction level, described in greater detail herein.

In various embodiments, the EBC system **120** may be implemented to use certain EBC data and an associated abstraction level to generate a hierarchical set of entity behaviors **1070**, described in greater detail herein. In certain embodiments, the hierarchical set of entity behaviors **1070** generated by the EBC system may represent an associated security risk, likewise described in greater detail herein. Likewise, as described in greater detail herein, the EBC system may be implemented in certain embodiments to store the hierarchical set of entity behaviors **1070** and associated

abstraction level information within a repository of EBC data. In certain embodiments, the repository of EBC data **440** can be implemented to provide an inventory of entity behaviors for use when performing a security operation, likewise described in greater detail herein.

Referring now to FIG. **10**, the EBC system may be implemented in various embodiments to receive certain event information, described in greater detail herein, corresponding to an event associated with an entity interaction, likewise described in greater detail herein. As used herein, event information broadly refers to any information directly or indirectly related to an event, described in greater detail herein.

In certain embodiments, information associated with an entity attribute, likewise described in greater detail herein, and an entity behavior may be respectively abstracted to an entity attribute **1072** and an entity behavior **1074** abstraction level. In certain embodiments, an entity attribute **1072** and an entity behavior **1074** abstraction level may then be associated with an event **1076** abstraction level. In certain embodiments, the entity attribute **1072**, entity behavior **1074**, and event **1076** abstraction levels may in turn be associated with a corresponding entity behavior hierarchy **1070**, as described in greater detail herein.

In various embodiments, the event information may be received from certain event data sources **1010**, such as a user **704** entity, an endpoint **1004** non-user entity, a network **1006** non-user entity, a system **1008** non-user entity, or a data **708** entity. In certain embodiments, one or more events may be associated with a particular entity interaction. As an example, as shown in FIG. **10**, one or more events $i+n$ **1012** may be associated with a user/device **930** interaction between a user **704** entity and an endpoint **1004** non-user entity. Likewise, one or more events $j+n$ **1014** may be associated with a user/network **942** interaction between a user **704** entity and a network **1006** non-user entity. As likewise shown in FIG. **10**, one or more events $k+n$ **1016** may be associated with a user/resource **948** interaction between a user **704** entity and a system **1008** non-user entity, or a data **708** entity, or a combination of the two.

In certain embodiments, details of an event, such as events $i+n$ **1012**, $j+n$ **1014**, and $k+n$ **1016**, may be included in their associated event information. In various embodiments, as described in greater detail herein, analytic utility detection operations may be performed on such event information to identify events of analytic utility. In various embodiments, certain event information associated with an event determined to be of analytic utility may be used to derive a corresponding observable.

As an example, the details contained in the event information respectively corresponding to events $i+n$ **1012**, $j+n$ **1014**, and $k+n$ **1016** may be used to derive observables $i+n$ **1022**, $j+n$ **1024**, and $k+n$ **1026**. In certain embodiments, the resulting observables $i+n$ **1022**, $j+n$ **1024**, and $k+n$ **1026** may then be respectively associated with a corresponding observable **1078** abstraction level. In certain embodiments, the observable **1078** abstraction level may in turn be associated with a corresponding entity behavior hierarchy **1070**, as described in greater detail herein.

In certain embodiments, the resulting observables may in turn be processed to generate an associated IOB. For example, observables $i+n$ **1022**, $j+n$ **1024**, and $k+n$ **1026** may in turn be processed to generate corresponding IOBs i **1032**, j **1034**, and k **1036**. In certain embodiments, the resulting IOBs, i **1032**, j **1034**, and k **1036** may then be respectively associated with a corresponding IOB **1080** abstraction level. In certain embodiments, the IOB **1080**

abstraction level may in turn be associated with a corresponding entity behavior hierarchy **1070**, as described in greater detail herein.

In various embodiments, sessionization and fingerprint generation operations **1020**, described in greater detail herein, may be performed to associate certain events, observables, and security related activities, or a combination thereof, with a corresponding session, likewise described in greater detail herein. As an example, events $i+n$ **1012**, $j+n$ **1014**, $k+n$ **1016**, observables $i+n$ **1022**, $j+n$ **1024**, $k+n$ **1026**, and IOBs i **1032**, j **1034**, k **1036** may be associated with corresponding sessions. In certain embodiments, an IOB may be processed with associated contextual information, described in greater detail herein, to generate a corresponding EBP element.

For example, IOBs i **1032**, j **1034**, and k **1036** may be processed with associated contextual information to generate corresponding EBP elements i **1042**, j **1044**, and k **1046**. In various embodiments, the resulting EBP elements i **1042**, j **1044**, and k **1046** may then be associated with a corresponding EBP element **1082** abstraction level. In certain embodiments, the EBP element **1082** abstraction level may in turn be associated with a corresponding entity behavior hierarchy **1070**, as described in greater detail herein.

In certain embodiments, EBP generation and management **1040** operations may be performed to associate one or more EBP elements with a particular EBP **540**. As an example, EBP elements i **1042**, j **1044**, and k **1046** may be associated with a particular EBP **420**, which may likewise be respectively associated with the various entities involved in the user/device **930**, user/network **942**, or user/resource **948** interactions. In these embodiments, the method by which the resulting EBP elements i **1042**, j **1044**, and k **1046** are associated with a particular EBP **420** is a matter of design choice. In certain embodiments, the EBP **420** may likewise be associated with an EBP **1084** abstraction level. In certain embodiments, the EBP **1084** abstraction level may in turn be associated with a corresponding entity behavior hierarchy **1070**, as described in greater detail herein.

In various embodiments, the resulting EBP **420** may be used in the performance of security risk use case association **1050** operations to identify one or more security risk use cases that match certain entity behavior information stored in the EBP **540**. In certain of these embodiments, the entity behavior information may be stored within the EBP **420** in the form of an EBP element. In certain embodiments, identified security risk use cases may then be associated with a security risk use case **1086** abstraction level. In certain embodiments, the security risk use case **1086** abstraction level may in turn be associated with a corresponding entity behavior hierarchy **1070**, as described in greater detail herein.

In certain embodiments, the results of the security risk use case association **1050** operations may in turn be used to perform security vulnerability scenario inference **1060** operations to associate one or more security risk use cases with one or more security vulnerability scenarios, described in greater detail herein. In certain embodiments, the associated security vulnerability scenarios may then be associated with a security vulnerability scenario **1088** abstraction level. In certain embodiments, the security vulnerability scenario **1088** abstraction level may in turn be associated with a corresponding entity behavior hierarchy **1070**, as described in greater detail herein.

In various embodiments, certain event information associated with events $i+n$ **1012**, $j+n$ **1014**, and $k+n$ **1016** and certain observable information associated with observables

i+n 1022, j+n 1024, and k+n 1026 may be stored in a repository of EBC data. In various embodiments, certain IOB information associated with security related activities i 1032, j 1034, and k 1036 and EBP elements i 1042, j 1044, and k 1046 may likewise be stored in the repository of EBC data. Likewise, in various embodiments, certain security risk use case association and security vulnerability scenario association information respectively associated with the performance of security risk use case association 1050 and security vulnerability scenario inference 1060 operations may be stored in the repository of EBC data.

FIG. 11 is a simplified block diagram of the generation of a session and a corresponding session-based fingerprint implemented in accordance with an embodiment of the invention. In certain embodiments, an observable 1106 may be derived from an associated event, as described in greater detail herein. In certain embodiments, one or more observables 11026 may be processed to generate a corresponding indicator of behavior (IOB) 1108, as likewise described in greater detail herein.

In certain embodiments, one or more IOBs 1108 may then be respectively processed to generate a corresponding activity session 1110. In turn, the session 1110 may be processed in certain embodiments to generate a corresponding session fingerprint 1112. In certain embodiments, the resulting activity session 910 and its corresponding session fingerprint 1112, individually or in combination, may then be associated with a particular entity behavior profile (EBP) element 1180. In certain embodiments the EBP element 1180 may in turn be associated with an EBP 420.

In certain embodiments, intervals in time 1104 respectively associated with various IOBs 1108 may be contiguous. For example, as shown in FIG. 11, the intervals in time 1104 associated with observables 1106 '1' 1114 and '2' 1116 may be contiguous. Accordingly, the intervals in time 1104 associated with IOBs 1108 '1' 1118 and '2' 1120 respectively generated from observables 1106 '1' 1114 and '2' 1116 would likewise be contiguous.

As likewise shown in FIG. 11, the resulting IOBs 1108 '1' 1118 and '2' 1120 may be processed to generate an associated activity session 'A' 1122, which then may be processed to generate a corresponding session fingerprint 'A' 1124. In certain embodiments, activity session 'A' 1122 and its corresponding session fingerprint 'A' 1124 may be used to generate a new entity behavior profile (EBP) element 1180 'A' 1126. In certain embodiments, EBP element 1180 'A' 1126 generated from activity session 1110 'A' 1122 and its corresponding session fingerprint 1112 'A' 1125 may be associated with an existing EBP 420.

To provide an example, a user may enact various observables 1106 '1' 1114 to update sales forecast files, followed by the enactment of various observables 1106 '2' 1116 to attach the updated sales forecast files to an email, which is then sent to various co-workers. In this example, the enactment of observables 1106 '1' 1114 and '2' 1116 result in the generation of IOBs 1108 '1' 1118 and '2' 1120, which in turn are used to generate activity session 1110 'A' 1122. In turn, the resulting activity session 1110 'A' 1122 is then used to generate its corresponding session-based fingerprint 1112 'A' 1124. To continue the example, activity session 1110 'A' 1122 is associated with security related activities 1108 '1' 1118 and '2' 1120, whose associated intervals in time 1104 are contiguous, as they are oriented to the updating and distribution of sales forecast files via email.

Various aspects of the invention reflect an appreciation that a user may enact certain entity behaviors on a recurring basis. To continue the preceding example, a user may

typically update sales forecast files and distribute them to various co-workers every morning between 8:00 AM and 10:00 AM. Accordingly, the activity session 1110 associated with such a recurring activity may result in a substantively similar session fingerprint 1112 week-by-week. However, a session fingerprint 1112 for the same session 1110 may be substantively different should the user happen to send an email with an attached sales forecast file to a recipient outside of their organization. Consequently, a session fingerprint 1112 that is inconsistent with session fingerprints 1112 associated with past activity sessions 1110 may indicate anomalous, abnormal, unexpected or suspicious behavior.

In certain embodiments, two or more activity sessions 1110 may be noncontiguous, but associated. In certain embodiments, an activity session 1110 may be associated with two or more sessions 1110. In certain embodiments, an activity session 1110 may be a subset of another activity session 1110. As an example, as shown in FIG. 11, the intervals in time 1104 respectively associated with observables 1106 '3' 1114 and '6' 1132 may be contiguous. Likewise, the intervals in time 1104 associated with observables 1106 '4' 1136 and '5' 1138 may be contiguous.

Accordingly, the intervals in time 904 associated with the IOBs 1108 '4' 1136 and '5' 1138 respectively generated from observables 1106 '4' 1128 and '5' 1130 would likewise be contiguous. However, the intervals in time 1104 associated with IOBs 1108 '4' 1136 and '5' 1138 would not be contiguous with the intervals in time respectively associated with IOBs 1108 '3' 1134 and '6' 1140.

As likewise shown in FIG. 11, the resulting IOBs 1108 '3' 1134 and '6' 1140 may be respectively processed to generate corresponding sessions 'B' 1142 and 'D' 1146, while IOBs 1108 '4' 1136 and '5' 1138 may be processed to generate activity session 1110 'C' 1144. In turn, activity sessions 1110 'B' 1142, 'C' 1144, and 'D' 1146 are then respectively processed to generate corresponding session-based fingerprints 1112 'B' 1148, 'C' 1150 and 'D' 1152.

Accordingly, the intervals of time 1104 respectively associated with activity sessions 1110 'B' 1142, 'C' 1144, and 'D' 1146, and their corresponding session fingerprints 1112 'B' 1148, 'C' 1150 and 'D' 1152, are not contiguous. Furthermore, in this example activity sessions 1110 'B' 1142, 'C' 1144, and 'D' 1146, and their corresponding session fingerprints 1112 'B' 1148, 'C' 1150 and 'D' 1152, are not associated with the EBP 420. Instead, as shown in FIG. 11, activity sessions 1110 'B' 1142, 'C' 1144, and 'D' 1146 are processed to generate activity session 1110 'E' 1154 and session fingerprints 1112 'B' 1148, 'C' 1150 and 'D' 1152 are processed to generate session fingerprint 1112 'E' 1156. In certain embodiments, activity session 'E' 1154 and its corresponding session fingerprint 'E' 1156 may be used to generate a new EBP element 1180 'E' 1158. In certain embodiments, EBP element 1180 'E' 1158 generated from activity session 1110 'E' 1154 and its corresponding session fingerprint 1112 'E' 1156 may be associated with an existing EBP 420.

Accordingly, activity session 1110 'E' 1154 is associated with activity sessions 1110 'B' 1142, 'C' 1144, and 'D' 1146. Likewise, activity sessions 1110 'B' 1142, 'C' 1144, and 'D' 1146 are subsets of activity session 1110 'E' 1154. Consequently, while the intervals of time respectively associated with activity sessions 1110 'B' 1142, 'C' 1144, and 'D' 1146, and their corresponding session fingerprints 1112 'B' 1148, 'C' 1150 and 'D' 1152 may not be contiguous, they are

associated as they are respectively used to generate activity session 1110 'E' 1154 and its corresponding session fingerprint 1112 'E' 1156.

To provide an example, a user plans to attend a meeting scheduled for 10:00 AM at a secure facility owned by their organization to review a project plan with associates. However, the user wishes to arrive early to prepare for the meeting. Accordingly, they arrive at 9:00 AM and use their security badge to authenticate themselves and enter the facility. In this example, the enactment of observables 1106 '3' 1126 may correspond to authenticating themselves with their security badge and gaining access to the facility. As before, observables 1106 '3' 1126 may be used to generate a corresponding IOB 1108 '3' 1134. In turn, the IOB 1108 '3' 1134 may then be used to generate session 1110 'B' 1142, which is likewise used in turn to generate a corresponding session fingerprint 1112 'B' 1148.

The user then proceeds to a conference room reserved for the meeting scheduled for 10:00 AM and uses their time alone to prepare for the upcoming meeting. Then, at 10:00 AM, the scheduled meeting begins, followed by the user downloading the current version of the project plan, which is then discussed by the user and their associate for a half hour. At the end of the discussion, the user remains in the conference room and spends the next half hour making revisions to the project plan, after which it is uploaded to a datastore for access by others.

In this example, observables 1106 '4' 1128 may be associated with the user downloading and reviewing the project plan and observables 1106 '5' 1130 may be associated with the user making revisions to the project plan and then uploading the revised project plan to a datastore. Accordingly, observables 1106 '4' 1128 and '5' 1130 may be respectively used to generate IOBs 1108 '4' 1136 and '5' 1138. In turn, IOBs 1108 '4' 1136 and '5' 1138 may then be used to generate activity session 1110 'C' 1144, which may likewise be used in turn to generate its corresponding session fingerprint 1112 'C' 1150.

To continue the example, the user may spend the next half hour discussing the revisions to the project plan with a co-worker. Thereafter, the user uses their security badge to exit the facility. In continuance of this example, observable 1106 '6' 1132 may be associated with the user using their security badge to leave the secure facility. Accordingly, observable 1106 '6' 1132 may be used to generate a corresponding IOB 1108 '6' 1140, which in turn may be used to generate a corresponding activity session 1110 'D' 1146, which likewise may be used in turn to generate a corresponding session fingerprint 1112 'D' 1152.

In this example, the intervals of time 1104 respectively associated with activity sessions 1110 'B' 1142, 'C' 1144, and 'D' 1146, and their corresponding session fingerprints 1112 'B' 1148, 'C' 1150, and 'D' 1152, are not contiguous. However they may be considered to be associated as their corresponding observables 1106 '3' 1126, '4' 1128, '5' 1130, and '6' 1132 all have the common attribute of having been enacted within the secure facility. Furthermore, security related activities 1108 '4' 1136 and '5' 1138 may be considered to be associated as their corresponding observables 1106 have the common attribute of being associated with the project plan.

Accordingly, while the intervals of time 1104 respectively associated with activity sessions 1110 'B' 1142, 'C' 1144, and 'D' 1146, and their corresponding session fingerprints 1112 'B' 1148, 'C' 1150, and 'D' 1152, may not be contiguous, they may be considered to be associated. Consequently, activity sessions 1110 'B' 1142, 'C' 1144, and 'D' 1146 may

be considered to be a subset of activity session 1110 'E' 1154 and session fingerprints 1112 'B' 1148, 'C' 1150, and 'D' 1152 may be considered to be a subset of session fingerprint 1112 'E' 1156.

In certain embodiments, the interval of time 1104 corresponding to a first activity session 1110 may overlap an interval of time 1104 corresponding to a second activity session 1110. For example, observables 1106 '7' 1158 and '8' 1160 may be respectively processed to generate IOBs 1108 '7' 1162 and '8' 1164. In turn, the resulting IOBs 1108 '7' 1162 and '8' 1164 are respectively processed to generate corresponding activity sessions 1110 'F' 1166 and 'G' 1168. The resulting activity sessions 1110 'F' 1166 and 'G' 1168 are then respectively processed to generate corresponding session fingerprints 1112 'F' 1170 and 'G' 1172.

However, in this example activity sessions 1110 'F' 1166 and 'G' 1168, and their corresponding session fingerprints 1112 'F' 1170 and 'G' 1172, are not associated with the EBP 420. Instead, as shown in FIG. 11, activity sessions 1110 'F' 1166 and 'G' 1168 are processed to generate activity session 1110 'E' 1154 and session fingerprints 1112 'F' 1170 and 'G' 1172 are processed to generate session fingerprint 1112 'H' 1176. In certain embodiments, activity session 'H' 1174 and its corresponding session fingerprint 'H' 1176 may be used to generate a new EBP element 1180 'H' 1178. In certain embodiments, EBP element 1180 'H' 1178 generated from activity session 1110 'E' 1174 and its corresponding session fingerprint 1112 'E' 1176 may be associated with an existing EBP 420.

Accordingly, the time 1104 interval associated with activity session 1110 'F' 1166 and its corresponding session fingerprint 1112 'F' 1170 overlaps with the time interval 1104 associated with activity session 1110 'G' 1168 and its corresponding session fingerprint 1112 'G' 1172. As a result, activity sessions 1110 'F' 1166 and 'G' 1168 are subsets of activity session 1110 'H' 1174. Consequently, while the intervals of time respectively associated with activity sessions 1110 'F' 1166 and 'G' 1168, and their corresponding session fingerprints 1112 'F' 1170 and 'G' 1172 may overlap, they are associated as they are respectively used to generate activity session 1110 'H' 1174 and its corresponding session fingerprint 1112 'H' 1176.

To provide an example, a user may decide to download various images for placement in an online publication. In this example, observables 1106 '7' 1158 may be associated with the user iteratively searching for, and downloading, the images they wish to use in the online publication. However, the user may not begin placing the images into the online publication until they have selected and downloaded the first few images they wish to use.

To continue the example, observables 1106 '8' 1164 may be associated with the user placing the downloaded images in the online publication. Furthermore, the placement of the downloaded images into the online publication may begin a point in time 1104 subsequent to when the user began to download the images. Moreover, the downloading of the images may end at a point in time 1104 sooner than when the user completes the placement of the images in the online publication.

In continuance of the example, observables 1106 '7' 1158 and '8' 1160 may be respectively processed to generate IOBs 1108 '7' 1162 and '8' 1164, whose associated intervals of time 1104 overlap one another. Accordingly, the intervals in time 1104 associated with activity sessions 1110 'F' 1166 and 'G' 1168 will likewise overlap one another as they are respectively generated from IOBs 1108 '7' 1162 and '8' 1164.

Consequently, while the intervals of time **1104** respectively associated with activity sessions **1110** ‘F’ **1166** and ‘G’ **1168**, and their corresponding session fingerprints **1112** ‘F’ **1170** and ‘G’ **1172**, may overlap, they may be considered to be associated as they both relate to the use of images for the online publication. Accordingly, activity sessions **1110** ‘F’ **1166** and ‘G’ **1168** may be considered to be a subset of activity session **1110** ‘H’ **1174** and session fingerprints **1112** ‘F’ **1170** and ‘G’ **1172** may be considered to be a subset of session fingerprint **1112** ‘H’ **1176**.

FIGS. **12a** and **12b** are a simplified block diagram showing reference architecture components of an entity behavior catalog (EBC) system implemented in accordance with an embodiment of the invention for performing certain EBC operations. In various embodiments, the EBC system **120** may be implemented to generate, manage, store, or some combination thereof, information related to the behavior of an associated entity. In certain embodiments, the EBC system **120** may be implemented to provide an inventory of entity behaviors for use when performing a security operation, described in greater detail herein.

In certain embodiments, an EBC system **120** may be implemented to identify an indicator of behavior (IOB), described in greater detail herein. In certain embodiments, the IOB may be based upon an observable, likewise described in greater detail herein. In certain embodiments, the observable may include event information corresponding to electronically-observable behavior enacted by an entity. In certain embodiments, the event information corresponding to electronically-observable behavior enacted by an entity may be received from an electronic data source, such as the event data sources **1010** shown in FIGS. **10**, **12b**, and **13**.

In certain embodiments, as likewise described in greater detail herein, the EBC system **120** may be implemented to identify a particular event of analytic utility by analyzing an observable **1106** associated with a particular indicator of behavior (IOB) **1108**, described in greater detail herein. In certain embodiments, the EBC system **120** may be implemented to generate entity behavior catalog data based upon an identified event of analytic utility. In certain embodiments, an observable **1106** may be derived, as described in greater detail herein, from an identified event of analytic utility. In various embodiments, the EBC system **120** may be implemented to associate certain entity behavior data it may generate with a predetermined abstraction level, described in greater detail herein.

In various embodiments, the EBC system **120** may be implemented to use certain entity behavior catalog data, and an associated abstraction level, to generate a hierarchical set of entity behaviors, described in greater detail herein. In certain embodiments, the hierarchical set of entity behaviors generated by the EBC system **120** may represent an associated security risk, likewise described in greater detail herein. Likewise, as described in greater detail herein, the EBC system **120** may be implemented in certain embodiments to store the hierarchical set of entity behaviors within a repository of EBC data.

In various embodiments, the EBC system **120** may be implemented to receive certain event information, described in greater detail herein, corresponding to an event associated with an entity interaction, likewise described in greater detail herein. In various embodiments, the event information may be generated by, received from, or a combination thereof, certain event data sources **1010**. In certain embodiments, such event data sources **1010** may include endpoint devices **204**, edge devices **304**, identity and access **1204**

systems familiar to those of skill in the art, as well as various software and data security **1206** applications. In various embodiments, event data sources **1010** may likewise include output from certain processes **1208**, network **1210** access and traffic logs, domain **1212** registrations and associated entities, certain resources **950**, described in greater detail herein, event logs **1214** of all kinds, and so forth.

In certain embodiments, EBC system **120** operations are begun with the receipt of information associated with a particular event. In certain embodiments, information associated with the event may include user entity profile attributes, user behavior factors, user entity mindset factors, entity state information, and contextual information, described in greater detail herein, or a combination thereof.

In various embodiments, the event may be associated with certain entity interactions, likewise described in greater detail herein. In various embodiments, certain user entity profile data, user entity mindset profile data, non-user entity profile data, entity state data, contextual information, and temporal information stored in the repository of EBC data may be retrieved and then used to perform event enrichment operations to enrich and contextualize the information associated with the event.

In various embodiments, an observable **1106**, described in greater detail herein, may be derived from the resulting enriched, contextualized event. As shown in FIG. **12b**, examples of such observables **1106** may include firewall file download **1218**, data loss protection (DLP) download **1220**, and various operating system (OS) events **1222**, **1226**, and **1234**. As likewise shown in FIG. **12b**, other examples of such observables **1106** may include cloud access security broker (CASB) events **1224** and **1232**, endpoint spawn **1228**, insider threat process start **1230**, DLP share **1236**, and so forth. In certain embodiments, the resulting observables **1106** may in turn be respectively associated with a corresponding observable abstraction level, described in greater detail herein.

In certain embodiments, IOB abstraction operations, described in greater detail herein, may be performed on the resulting observables **1106** to generate a corresponding IOB **1108**. In various embodiments, an IOB **1108** may be expressed in a Subject→Action→Object format and associated with observables **1106** resulting from event information received from certain event data sources **1010**. In certain embodiments, an IOB abstraction operation may be performed to abstract away event data source-specific knowledge and details when expressing an entity behavior. For example, rather than providing the details associated with a “Windows:4624” non-user entity event, the IOB **1108** may be abstracted to a “User Login To Device” OS event **1222**, **1226**, **1234**.

As shown in FIG. **12b**, examples of IOBs **1108** may include “user downloaded document” **1222**, “device spawned process” **1244**, “user shared folder” **1246**, and so forth. To provide other examples, the IOB **1108** “user downloaded document” **1222** may be associated with observables **1106** firewall file download **1218**, DLP download **1220**, OS event **1222**, and CASB event **1224**. Likewise, the IOB **1108** “device spawned process” **1244**, may be associated with observables **1106**, OS event **1226**, endpoint spawn **1228**, and insider threat process start **1230**. The IOB **1108** “user shared folder” **1246** may likewise be associated with observables **1106** CASB event **1232**, OS event **1234**, and DLP share **1236**.

In certain embodiments, IOBs **1108** may in turn be respectively associated with a corresponding IOB abstraction level, described in greater detail herein. In various

embodiments, activity sessionization operations, likewise described in greater detail herein, may be performed to respectively associate certain events and IOBs **1108** with corresponding activity sessions, likewise described in greater detail herein. Likewise, as described in greater detail herein, the resulting session information may be used in various embodiments to associate certain events of analytic utility, or their corresponding observables **1106**, or their corresponding IOBs **1108**, or a combination thereof, with a particular activity session.

In certain embodiments, the resulting IOBs **1108** may be processed to generate an associated EBP element **1180**, as described in greater detail herein. In various embodiments, the EBP element **1180** may include user entity profile attribute **604**, non-user entity profile attribute **634**, data entity profile attribute **644**, entity risk score **540**, entity state **542**, entity model **544**, entity behavior **1248** information, and so forth. In certain of these embodiments, the actual information included in a particular EBP element **1180**, the method by which it is selected, and the method by which it is associated with the EBP element **1180**, is a matter of design choice. In certain embodiments, the EBP elements **1180** may in turn be respectively associated with a corresponding EBP element abstraction level, described in greater detail herein.

In various embodiments, certain EBP elements **1180** may in turn be associated with a particular EBP **540**. In certain embodiments, the EBP **540** may be implemented as a class of user entity **1252** EBPs, an user entity-specific **1254** EBP, a class of non-user entity **1256** EBPs, a non-user entity-specific **1258** EBP, a class of data entity EBPs **1260**, a data entity-specific **1262** EBP, and so forth. In various embodiments, certain entity data associated with EBP elements **1180** associated with the classes of user entity **1252**, non-user entity **1256**, and data entity **1260** EBPs may be anonymized. In certain embodiments, the EBP **540** may in turn be associated with an EBP abstraction level, described in greater detail herein.

In certain embodiments, security risk use case association operations may be performed to associate an EBP **540** with a particular security risk use case **1270**. As shown in FIG. **12a**, examples of such security risk use cases **1270** include “data exfiltration” **1272**, “data stockpiling” **1274**, “compromised insider” **1276**, “malicious user” **1278**, and so forth. In certain embodiments, identified security risk use cases may in turn be associated with a security risk use case abstraction level, described in greater detail herein.

In certain embodiments, the results of the security risk use case association operations may be used to perform security vulnerability scenario association inference operations to associate one or more security risk use cases **1270** to one or more security vulnerability scenario inferences **1280**, described in greater detail herein. As shown in FIG. **12a**, examples of security vulnerability scenario inferences **1280** include “accidental disclosure” **1282**, “account takeover” **1284**, “theft of data” **1286**, “sabotage” **1288**, “regulatory compliance” **1290**, “fraud” **1292**, “espionage” **1294**, and so forth. To continue the example, the “theft of data” **1286** security vulnerability scenario inference may be associated with the “data exfiltration” **1272**, “data stockpiling” **1274**, “compromised insider” **1276**, “malicious user” **1278** security risk use cases **1270**. Likewise the “sabotage” **1288** and “fraud” **1292** security vulnerability scenario inferences may be respectively associated with some other security risk case **1270**. In certain embodiments, the associated security vul-

nerability scenarios may in turn be associated with a security vulnerability scenario abstraction level, described in greater detail herein.

FIG. **13** is a simplified block diagram showing the mapping of entity behaviors to a risk use case scenario implemented in accordance with an embodiment of the invention. In certain embodiments, an entity behavior catalog (EBC) system **120** may be implemented, as described in greater detail herein, to receive event information from a plurality of event data sources **1010**, which is then processed to determine whether a particular event is of analytic utility. In certain embodiments, the EBC system **120** may be implemented to derive observables **1106** from identified events of analytic utility, as likewise described in greater detail herein. In certain embodiments, the EBC system **120** may be implemented, as described in greater detail herein, to associate related observables **1106** with a particular indicator of behavior (IOB) **1108**, described in greater detail herein, which in turn is associated with a corresponding security risk use case **1050**. In various embodiments, certain contextual information may be used, as described in greater detail herein, to determine which IOBs **1108** may be associated with which security risk use cases **1050**.

In certain embodiments, a single **1360** IOB **1108** may be associated with a particular security risk use case **1050**. For example, as shown in FIG. **13**, event data may be received from a Unix/Linux® event log **1302** and a Windows® directory **1304**. In this example, certain event data respectively received from the Unix/Linux® event log **1302** and Windows® directory **1304** may be associated with an event of analytic utility, which results in the derivation of observables **1106** “File In Log Deleted” **1322** and “Directory Accessed” **1324**. To continue the example, the resulting observables **1106** “File In Log Deleted” **1322** and “Directory Accessed” **1324** may then be associated with IOB **1108** “Event Log Cleared” **1344**. In turn, IOB **1108** “Event Log Cleared” **1344** may be associated with security risk use case **1050** “Administrative Evasion” **1358**.

In certain embodiments, two or more **1364** IOBs **1108** may be associated with a particular security risk use case **1050**. For example, as shown in FIG. **13**, event data may be received from an operating system (OS) **1306**, an insider threat **1308** detection system, an endpoint **1310** and a firewall **1312**. In this example, certain event data respectively received from the operating system (OS) **1306**, the insider threat **1308** detection system, the endpoint **1310** and the firewall **1312** may be associated with an event of analytic utility. Accordingly, observables **1106** “Security Event ID” **1326**, and “New Connection” **1328**, may be respectively derived from the event data of analytic utility received from the endpoint **1310** and the firewall **1312** event data sources **1010**. Likewise, observables **1106** “Connection Established” **1330** and “Network Scan” **1332** may be respectively derived from the event data of analytic utility received from the OS **1306** and the insider threat **1308** detection system event data sources **1010**.

To continue the example, the resulting observables **1106** “Security Event ID” **1326**, “New Connection” **1328** and “Connection Established” **1330** may be associated with IOB **1108** “Device Connected To Port” **1346**. Likewise, observable **1106** “Network Scan” **1332** may be associated with IOB **1108** “Network Scan” **1348**. In turn, IOBs **1108** “Device Connected To Port” **1346** and “Network Scan” **1332** may be associated with security risk use case **1050** “Internal Horizontal Scanning” **1362**.

In certain embodiments, a complex set **1368** of IOBs **1108** may be associated with a particular security risk use case

1050. For example, as shown in FIG. 13, event data may be received from an OS 1314, an internal cloud access security broker (CASB) 1316, an external CASB 1318, and an endpoint 1320. In this example, certain event data respectively received from the OS 1314, the internal cloud access security broker (CASB) 1316, the external CASB 1318, and the endpoint 1320 may be associated with an event of analytic utility.

Accordingly, observables 1106 “OS Event” 1334, “CASB Event” 1340, and “New Application” 1342 may be respectively derived from the event data of analytic utility provided by the OS 1314, the external CASB 1318, and the endpoint 1320 event data sources 1010. Likewise, a first “CASB Event ID” 1336 observable 1106 and a second “CASB Event ID” 1338 observable 1106 may both be derived from the event data of analytic utility received from the internal CASB 1316 event data source 1010.

To continue the example, the “OS Event” 1334, the first “CASB Event ID” 1336, and “New Application” 1342 observables 1106 may then be respectively associated with IOBs 1108 “New USB Device” 1350, “Private Shareable Link” 1352, and “File Transfer Application” 1356. Likewise, second “CASB Event ID” 1338 observable 1106 and the “CASB Event” 1340 observable 1106 may then be associated with IOB 1108 “Public Shareable Link” 1354. In turn, the IOBs 1108 “New USB Device” 1350, “Private Shareable Link” 1352, “Public Shareable Link” 1354, and “File Transfer Application” 1356 may be associated with security risk use case 1050 “Data Exfiltration Preparations” 1366.

FIG. 14 is a simplified block diagram of the performance of a human factors risk operation implemented in accordance with an embodiment of the invention. In various embodiments, information associated with certain human factors 430, described in greater detail herein, may be processed with information associated with certain indicators of behavior (IOBs) 1108 to detect a corresponding concerning behavior 1414. As used herein, a concerning behavior 1414 broadly refers to an IOB 1108 whose associated enactment of entity behavior may be considered a potential security risk. In certain embodiments, the entity behavior associated with an IOB 1108 may be enacted by a user entity, a non-user entity, or a data entity, or a combination thereof.

In certain embodiments, the human factors 430 may include cardinal traits 1402, emotional stressors 1404, and organizational dynamics 1406, or a combination thereof, likewise described in greater detail herein. In certain embodiments, as likewise described in greater detail herein, one or more entity behaviors associated with an IOB 1108 may be determined to be anomalous, abnormal, unexpected, suspicious, or some combination thereof. In these embodiments, the method by which a user entity behavior associated with an IOB 1108 is determined to be anomalous, abnormal, unexpected, suspicious, or some combination thereof, is a matter of design choice.

In various embodiments, certain information associated with a detected concerning behavior 1414 may be used in the performance of a human factors risk 1412 operation, described in greater detail herein, to infer an associated adverse effect 1416. As used herein, an adverse effect 1416 broadly refers to an unfavorable consequence resulting from the enactment of a concerning behavior 1414 by an entity. In certain embodiments, the enactment of a concerning behavior 1414 by a user entity may be characterized by a security risk persona, described in greater detail herein. In certain embodiments, an adverse effect 1416 may be described by

a security risk use case, or a security vulnerability scenario, or a combination of the two, likewise described in greater detail herein.

Certain embodiments of the invention reflect an appreciation that the occurrence of an adverse effect 1416 may result in a corresponding adverse outcome. As an example, an employee may attempt to access certain proprietary corporate data from their home computer on a weekend. While the employee may access such data on a regular basis from their place of employment during normal work hours, it is unusual for them to do so otherwise. In this example, the employee may be experiencing certain emotional stressors 1404, described in greater detail herein.

Those emotional stressors 1404, combined with anomalous entity behavior associated with an IOB 1108 related to attempting to access proprietary data from their home computer during non-work hours, may indicate enactment of a concerning behavior 1414. To continue the example, information associated with the detected concerning behavior 1414 may be used in the performance of a human factor risk operation 1412 to infer whether the employee’s concerning behavior 1414 might result in an adverse effect 1416. To complete the example, it may be inferred that the employee’s concerning behavior 1414 may correspond to a data exfiltration security vulnerability scenario, described in greater detail herein, which if successfully executed may result in the adverse outcome of proprietary corporate data being exfiltrated.

FIG. 15 is a simplified block diagram of the performance of an entity behavior meaning derivation operation implemented in accordance with an embodiment of the invention. In certain embodiments, one or more entity behavior meaning derivation 1532 operations may be performed to achieve a literal, inferential, and evaluative, or a combination thereof, understanding 1502, 1512, 1522, 1530, 1540 of the meaning of a particular entity’s associated entity behavior. In certain embodiments, information associated with the result of the entity behavior meaning derivation 1532 operation may be used to achieve an understanding of the risk corresponding to an associated adverse effect 1544.

In various embodiments, information associated with certain human factors, such as cardinal traits 1402, emotional stressors 1404, and organizational dynamics 1406, described in greater detail herein, or a combination thereof, may be used in an entity behavior meaning derivation 1532 operation to achieve an understanding 1502 of a user entity’s behavior. In various embodiments, information associated with certain non-user entity classes 1514, attributes 1516, and entity behavior history 1518, or a combination thereof, may likewise be used in an entity behavior meaning derivation 1532 operation to achieve an understanding 1512 of a non-user entity’s behavior. Likewise, in certain embodiments, information associated with certain data entity classes 1524, attributes 1526, and entity behavior history 1528, or a combination thereof, in an entity behavior meaning derivation 1532 operation to achieve an understanding 1522 of a data entity’s behavior.

FIG. 16 is a simplified block diagram of the performance of operations implemented in accordance with an embodiment of the invention to identify an enduring behavioral pattern corresponding to a particular user entity. In various embodiments, a user entity may enact certain entity behaviors associated with an indicator of behavior (IOB) 1108 over a particular period of time 1640. In certain embodiments, a human factors risk association operation, described in greater detail herein, may be performed to identify a particular cardinal trait 1402 corresponding to the enactment

of one or more such IOBs **1108**. In certain embodiments, an identified cardinal trait **1402**, such as “boundary pusher” **1628** may be persisted over time **1640** to reflect a particular enduring behavior pattern **1642** corresponding to the user entity.

For example, as shown in FIG. **16**, a user entity may enact an “unrecognized” **1604** indicator of behavior (IOB) **1108** at a particular point in time **1640**, which results in a corresponding “unrecognized” **1624** cardinal trait. At some point in time **1640** thereafter, the same user entity may enact a “data loss prevention (DLP) violation” **1606** IOB **1108**, which likewise results in a corresponding “unrecognized” **1624** cardinal trait. At some later point in time **1640** thereafter, the same user entity may enact an “abuses working from home policy” **1608** IOB **1108**. In this example, information associated with the enactment of the “unrecognized” **1604**, “DLP violation” **1606**, and “abuses working from home policy” **1608** IOBs **1108** may be used in the performance of a human factors risk association operation to determine the user entity personifies the cardinal trait of “boundary pusher” **1628**.

To continue the example, the user entity may enact IOBs **1108** at later points in time **1640**, including “DLP violation” **1610**, “unrecognized” **1612**, “requests access to sensitive files” **1614**, and “unrecognized” **1616**. However, the user entity’s identified cardinal trait of “boundary pusher” **1628** is persisted as an enduring behavior pattern **1642**. Those of skill in the art will recognize that many such embodiments and examples of cardinal traits **1402** being used to establish an enduring behavior pattern **1642** are possible. Accordingly, the foregoing is not intended to limit the spirit, scope, or intent of the invention.

FIG. **17** is a graphical representation of an ontology showing example emotional stressors implemented in accordance with an embodiment of the invention as a human factor. As described in greater detail herein, an emotional stressor **1404**, in combination with one or more other human factors, and one or more indicators of behavior (IOBs), may result in the occurrence of a concerning behavior. In certain embodiments, emotional stressors **1404** may be used in certain embodiments as a contextual modifier to provide meaningful context for detecting a concerning behavior, identifying an associated security risk case, or inferring a security risk vulnerability scenario, or a combination thereof. As used herein, a contextual modifier broadly refers to a circumstance, aspect, dynamic, attribute, or other consideration used to clarify, mitigate, exacerbate, or otherwise affect the perception, meaning, understanding, or assessment of a security risk associated with a particular IOB.

In certain embodiments, classes of emotional stressors **1404** may include personal **1704**, professional **1706**, financial **1708**, and legal **1710**. Certain embodiments of the invention reflect an appreciation that the effect of one or more emotional stressors **1404** on an associated user entity may result in the occurrence of a concerning behavior, described in greater detail herein, that may not represent a security risk. However, certain embodiments of the invention likewise reflect an appreciation that user entities engaging in both intentionally malicious and accidentally risky behaviors are frequently enduring personal **1704**, professional **1706**, financial **1708**, and legal **1710** emotional stressors **1404**.

As shown in FIG. **17**, examples of personal **1704** emotional stressors **1404** may include certain life changes, such as separation or divorce, marriage, the birth, death, or sickness of a family member or friend, health issues or injuries, pregnancy or adoption, and so forth. Likewise,

examples of professional **1706** emotional stressors **1404** may include termination or unsatisfactory performance reviews, retirement, business unit reorganization, changes in responsibility or compensation, co-worker friction, changes in work hours or location, and so forth.

Examples of financial **1708** emotional stressors **1404** may likewise include bankruptcy, foreclosure, credit issues, gambling addition, and so forth. Likewise, examples of legal **1710** emotional stressors **1404** contextual modifiers may include previous arrests, current arrests or incarceration, drug or driving under the influence (DUI) offenses, wage garnishment, and so forth. Skilled practitioners of the art will recognize that other **1712** classes of emotional stressors **1404** are possible. Accordingly, the foregoing is not intended to limit the spirit, scope, or intent of the invention.

FIG. **18** shows a mapping of data sources to emotional stressors implemented in accordance with an embodiment of the invention as a human factor. In various embodiments, individual emotional stressors **1404** may be implemented to receive input data from certain data sources. In certain embodiments, these data sources may include communication channels **1812** of various kinds, web activity **1814**, automated emails **1816**, human resources **1818** communications, credit reports **1820**, and background checks **1822**. Skilled practitioners of the art will recognize that individual emotional stressors **1404** may be implemented to receive input data from other data sources as well. Accordingly, the foregoing is not intended to limit the spirit, scope, or intent of the invention.

In certain embodiments, communication channels **1812** may include emails, chat (e.g., SLACK®), phone conversations (e.g., telephone, SKYPE®, etc.), and so forth. In various embodiments, natural language processing (NLP) approaches familiar to those of skill in the art may be implemented to identify certain emotional stressors **1404** within a particular communication channel **1812** exchange. In various embodiments, web activity **1814** may be monitored and processed to identify certain emotional stressors **1404**. In various embodiments, web activity **1814** may likewise be monitored and processed to identify certain web-related data fields, such as search terms, time stamps, domain classification, and domain risk class. In certain embodiments, auto-generated emails, especially from Human Capital Management (HCM) or Human Resource (HR) systems may be implemented to assist an organization identify and understand emotional stressors **1404** related to a user entity’s professional and life events. Likewise, data received for human resources **1818**, credit reports **1820**, and background checks **1822** may be implemented in certain embodiments to assist in identifying and understanding additional emotional stressors related to a particular user entity **1404**.

In certain embodiments, more than one data source may provide input data to a particular emotional stressor **1404**. For example, as shown in FIG. **18**, a professional **1706** emotional stressor may be implemented to receive input data from certain communication channels **1812**, web activity **1814**, automated emails **1816**, and human resources **1818** communications. Those of skill in the art will recognize that many such embodiments and examples are possible. Accordingly, the foregoing is not intended to limit the spirit, scope or intent of the invention.

FIG. **19** is a graphical representation of an ontology showing example organizational dynamics implemented in accordance with an embodiment of the invention as a human factor. As described in greater detail herein, the occurrence of an organizational dynamic **1406** may result in the occur-

rence of an associated concerning behavior. As described in greater detail herein, an organizational dynamic **1406**, in combination with one or more other human factors, and one or more indicators of behavior (IOBs), may result in the occurrence of a concerning behavior. In certain embodiments, classes of organizational dynamic **1406** may include security practices **1904**, communication issues **1906**, management systems **1908**, and work planning and control **1910**.

As shown in FIG. **19**, examples of security practices **1904** organizational dynamics **1406** include hiring practices, security training and controls, policy clarity, monitoring and tracking practices, and so forth. Likewise, examples of communication issues **1906** organizational dynamics **1406** include inadequate procedures, poor communications, and so forth. Examples of management systems **1908** organizational dynamics **1406** may likewise include distractions of various kinds, a non-productive environment, insufficient resources, and lack of career advancement. Other examples of management systems **1908** organizational dynamics **1406** may include poor management systems, job instability, poor work conditions, and so forth.

Likewise, examples of work planning and control **1910** organizational dynamics **1406** include job pressures of different sorts, workload, time factors, work role, task difficulty, lack of autonomy and power, change in routine, lack of breaks, and so forth. Skilled practitioners of the art will recognize that other **1912** classes of organizational dynamics **1406** are possible. Accordingly, the foregoing is not intended to limit the spirit, scope, or intent of the invention.

FIG. **20** shows a human factors risk modeling framework implemented in accordance with an embodiment of the invention. As used herein, human factors risk broadly refers to any risk associated with the enactment of a behavior by a user entity affected by one or more human factors, as described in greater detail herein. In certain embodiments, the human factors risk modeling framework **2000** shown in FIG. **20** may be used in combination with a human factors framework, described in greater detail herein, to perform a security analytics operation, likewise described in greater detail herein.

In various embodiments, the security analytics operation may be performed independently by the human factors framework, or in combination with certain components of a security analytics system, described in greater detail herein. Various embodiments of the invention reflect an appreciation that known approaches to human factors risk modeling have certain limitations that often pose challenges for security-related implementation. Likewise, various embodiments of the invention reflect an appreciation that implementation of the human factors risk modeling framework **2000** may assist in addressing certain of these limitations.

In certain embodiments, a user entity may enact certain entity behavior associated with a corresponding indicator of behavior (IOB) **1108**, described in greater detail herein. In certain embodiments, such user entity behaviors associated with a corresponding IOB **1108** may be determined to be anomalous, abnormal, unexpected, suspicious, or some combination thereof, as described in greater detail herein. In various embodiments, the human factors risk modeling framework **2000** may be implemented as a reference model for correlating certain human factors **430** associated with a particular user entity to certain anomalous, abnormal, unexpected, or suspicious behavior, or some combination thereof, they may enact.

In various embodiments, such correlation may result in the detection of an associated concerning behavior **1414**, described in greater detail herein. In certain embodiments,

such concerning behaviors **1414** may be detected as a result of the performance of a human factors risk operation, likewise described in greater detail herein. In certain embodiments, the effect of a particular concerning behavior **1414** may be qualitative, quantitative, or a combination of the two.

Referring now to FIG. **20**, an observable **1106**, described in greater detail herein, may be derived in various embodiments from one or more events of analytic utility **2004** associated with certain user entity behaviors **2002**, likewise described in greater detail herein. In certain embodiments, as likewise described in greater detail herein, one or more associated observables **1106** may be processed to generate a corresponding activity session **1110**. In various embodiments, certain information associated with a particular activity session **1110**, may be processed, as likewise described in greater detail herein, to generate a corresponding session fingerprint **1112**.

In various embodiments, certain human factor risk operations, described in greater detail herein, may be performed to identify one or more human factors **430**, likewise described in greater detail herein, associated with a particular user entity. In certain embodiments, such human factors **430** may include cardinal traits **1402**, emotional stressors **1404**, and organizational dynamics **1406**, or a combination thereof. In various embodiments, a security analytics operation, described in greater detail herein, may be performed to identify certain IOBs **1108** associated with a particular user entity. In certain embodiments, one or more human factor risk operations may be performed to correlate certain human factors **430** associated with the user entity to IOBs **1108** they may have enacted. In certain embodiments, the resulting correlation may result in the detection of an associated concerning behavior **1414**, described in greater detail herein.

In certain embodiments, information related to certain session fingerprints **1112**, human factors **430**, IOBs **1108**, and concerning behaviors **1414** may then be stored with other information contained in an entity profile (EBP) **420** associated with the user entity. In certain embodiments, the EBP **420** may then be implemented to identify a particular security risk use case **1270** corresponding to the user entity. In certain embodiments, the identified security risk use case **1270** may in turn correspond to a particular outcome-oriented kill chain **2024**, described in greater detail herein. In certain embodiments, the previously identified IOBs may correspond to a particular component **2026** of the outcome-oriented kill chain **2024**, as described in the descriptive text associated with FIG. **21**.

In certain embodiments, as likewise described in the descriptive text associated with FIG. **21**, each component **2006** of the outcome-oriented kill chain **2024** may be implemented to have a corresponding security risk persona **2028**. As used herein, a security risk persona **2028** broadly refers to a group of user entity behaviors **2002**, associated with a common theme, whose enactment is not explicitly related to a malicious objective. In various embodiments, certain user entity behaviors **2002** associated with a particular security risk use case **1270** may be used to define, or otherwise describe or characterize, a particular security risk persona **2028**. In these embodiments, the user entity behaviors **2002** selected for use, and the method by which the security risk persona **2008** is defined, or otherwise described or characterized, is a matter of design choice. In these embodiments, the descriptor selected to characterize a particular behavioral pattern exhibited by a user entity is likewise a matter of design choice.

In various embodiments, as described in greater detail herein, certain security risk personas **2028** may be implemented to track dynamic changes in user entity behaviors **2002**. In various embodiments, the ability to track dynamic changes in user entity behaviors **2002** may facilitate the identification and management of rapidly developing threats. Accordingly, certain embodiments of the invention reflect an appreciation that such tracking may be indicative of dynamic behavioral change associated with a particular user entity, such as associated IOBs **1108**. Likewise, various embodiments of the invention reflect an appreciation that certain security risk personas **2028** may shift, or transition, from one to another, and in doing so, reflect important shifts in user entity behaviors **2002** that are relevant to understanding a user entity's traversal of associated outcome-oriented kill chains **2024**.

In certain embodiments, a security risk persona **2028** may be used, as described in greater detail herein, to identify an associated security vulnerability scenario **1280**, likewise described in greater detail herein. In various embodiments, the identified security vulnerability scenario **1280** may be used in combination with certain other components of the human factors risk modeling framework **2000** to perform a user entity security risk assessment **2030**. In certain embodiments, performance of the user entity security risk assessment **2030** may result in the generation of a corresponding user entity risk score **2032**. In certain embodiments, the user entity risk score **2032** may be implemented as a numeric value. In certain embodiments, the numeric value of the user entity risk score **2032** may be implemented to quantitatively reflect the security risk associated with a particular concerning behavior **1414**.

In various embodiments, the user entity risk score **2032** may be implemented to be within a certain range of numeric values. In certain embodiments, the range of numeric values may be implemented to have a lower and upper bound. As an example, the user entity risk score **2032** for a particular concerning behavior **1414** may be implemented to have a lower bound of '0,' indicating extremely low risk, and an upper bound '100,' indicating extremely high risk. To illustrate the example, a user entity may initiate the detection of a concerning behavior **1414** by accessing a corporate server containing sales data, which in turn may result in the generation of an associated user entity risk score **2032** of '50.' In this example, the user entity risk score **2032** of '50' may indicate moderate risk. However, downloading the same sales data to a laptop computer may result in the generation of a concerning behavior risk score of '75,' indicating high risk. To further illustrate the example, downloading the same sales data to a laptop computer, and then storing the sales data on a flash drive, may result in the generation of a concerning behavior risk score of '90,' indicating very high risk.

In certain embodiments, the numeric value of a user entity risk score **2032**, or the upper and lower bounds of its associated range of numeric values, or both, may be implemented to be configurable. In certain embodiments, the selection of a numeric value for a particular user entity risk score **2032**, or the selection of the upper and lower bounds of its associated range of numeric values, or both, may be performed manually, automatically, or a combination thereof. In these embodiments, the numeric value selected for a particular user entity risk score **2032**, or the upper and lower bounds selected for its associated range of numeric values, or both, is a matter of design choice.

As described in greater detail herein, an EBP **420** may be implemented in certain embodiments to collect certain user

entity behavior **2002** and other information associated with a particular user entity. Examples of such information may include user entity attributes, such as their name, position, tenure, office location, working hours, and so forth. In certain embodiments, the EBP **420** may likewise be implemented to collect additional behavioral information associated with the human factors risk model **2000**. Examples of such additional information may include certain historical information associated with kill chain components **2006**, associated security risk personas **2008**, security vulnerability scenarios **1280**, indicators of behavior (IOBs) **1108**, and user entity risk scores **2032**.

As an example, an EBP **420** may contain the following user entity information:

User Entity Name: John Smith
 User Entity Risk Score: 50%
 Current Security Risk Persona: Wanderer
 Security Vulnerability Scenarios: Data Theft (Medium Confidence) Fraud (Low Confidence)
 Scenario Risk Score 55%

FIG. **21** shows security risk persona transitions associated with a corresponding outcome-oriented kill chain implemented in accordance with an embodiment of the invention. In certain embodiments, a security analytics system, a human factors framework, and an entity behavior catalog (EBC) system, or a combination thereof, may be implemented to monitor the behavior of a particular user entity, as described in greater detail herein. In certain embodiments, such monitoring may include observing an electronically-observable data source, such as the event data sources **1010** shown in FIGS. **10**, **12b**, and **13**.

In certain embodiments, an observable, described in greater detail herein, may be derived from an electronically-observable data source. In certain embodiments, the observable is associated with an event of analytic utility, likewise described in greater detail herein. In certain embodiments, one or more derived observables may then be associated with an indicator of behavior (IOB), as described in greater detail herein. In various embodiments, as likewise described in greater detail herein, a particular IOB activity may be associated with a component of a cyber kill chain.

Skilled practitioners of the art will be familiar with a kill chain, which was originally used as a military concept related to the structure of an attack. In general, the phases of a military kill chain consisted of target identification, force dispatch to target, decision and order to attack the target, and destruction of the target. Conversely, breaking or disrupting an opponent's kill chain is a method of defense or preemptive action. Those of skill in the art will likewise be familiar with a cyber kill chain, developed by the Lockheed Martin company of Bethesda, Maryland, which is an adaptation of the military kill chain concept that is commonly used to trace the phases of a cyberattack.

In certain embodiments, a cyber kill chain may be implemented to represent multi-stage, outcome-oriented user entity behaviors. In general, such outcome-oriented cyber kill chains will have at least two defined components. In certain embodiments, the components of an outcome-oriented cyber kill chain may be referred to, or implemented as, steps or phases of a kill chain. In certain embodiments, the components of an outcome-oriented cyber kill chain may be adapted, or otherwise implemented, for a particular type of cyberattack, such as data theft. For example, as shown in FIG. **21**, the components of a data theft kill chain **2130** may include data reconnaissance **2132**, data access **2134**, data collection **2136**, data stockpiling **2138**, and data exfiltration **2140**.

However, the cyber kill chain concept is not limited to data theft, which relates to theft of an organization's intellectual property. It can also be implemented to facilitate the anticipation and recognition of insider threats, such as insider sabotage, which includes any act by an insider to direct any kind of harm to an organization or its assets. Other insider threats include insider fraud, which relates to modification, deletion, or theft of an organization's data for personal gain, typically associated with the perpetration of an identity crime (e.g., identity theft, credit card fraud, etc.).

Yet other insider threats include unintentional insider threat, which includes any act, or failure to act, by an insider without malicious intent, that causes harm or substantially increases the probability of future harm to an organization or its assets. The cyber kill chain concept can likewise be implemented to address the occurrence, or possibility thereof, of workplace violence, which relates to any threat of physical violence, harassment, intimidation, or other threatening disruptive behavior in the workplace. Likewise, the cyber kill chain concept can be applied to social engineering, advanced ransomware, and innovative cyberattacks as they evolve.

In certain embodiments, a cyber kill chain may be implemented to anticipate, recognize, and respond to user entity behaviors associated with a corresponding indicator of behavior (IOB) that may be determined to be anomalous, abnormal, unexpected, suspicious, or some combination thereof, as described in greater detail herein. In certain embodiments, the response to recognition of a kill chain may be to perform an associated security operation, likewise described in greater detail herein. In certain embodiments, the performance of the security operation may result in disrupting or otherwise interfering with the performance, or execution, of one or more components, steps, or phases of a cyber kill chain by affecting the performance, or enactment, of the IOB by its associated entity.

In certain embodiments, a cyber kill chain may consist of more components, steps, or phases than those shown in the data theft kill chain **2130**. For example, in certain embodiments, the cyber kill chain may likewise include intrusion, exploitation, privilege escalation, lateral movement, obfuscation/anti-forensics, and denial of service (DoS). In such embodiments, the data reconnaissance **2132** component may be executed as an observation stage to identify targets, as well as possible tactics for the attack. In certain embodiments, the data reconnaissance **2132** component may not be limited to data exfiltration. For example, it may be related to other anomalous, abnormal, unexpected, malicious activity, such as identity theft.

In certain embodiments, the data access **2134** component may not be limited to gaining access to data. In certain embodiments, the data access **2134** component of a cyber kill chain may be executed as an intrusion phase. In such embodiments, the attacker may use what was learned in execution of the data reconnaissance **2132** component to determine how to gain access to certain systems, possibly through the use of malware or exploitation of various security vulnerabilities. In certain embodiments, a cyber kill chain may likewise include an exploitation component, which may include various actions and efforts to deliver malicious code and exploit vulnerabilities in order to gain a better foothold with a system, network, or other environment.

In certain embodiments, a cyber kill chain may likewise include a privilege escalation component, which may include various actions and efforts to escalate the attacker's privileges in order to gain access to more data and yet more

permissions. In various embodiments, a cyber kill chain may likewise include a lateral movement component, which may include moving laterally to other systems and accounts to gain greater leverage. In certain of these embodiments, the leverage may include gaining access to higher-level permissions, additional data, or broader access to other systems.

In certain embodiments, a cyber kill chain may likewise include an obfuscation/anti-forensics component, which may include various actions and efforts used by the attacker to hide or disguise their activities. Known obfuscation/anti-forensics approaches include laying false trails, compromising data, and clearing logs to confuse or slow down security forensics teams. In certain embodiments, the data **2136** collection component of a cyber kill chain may include the collection of data with the intent of eventually being able to exfiltrate it. In certain embodiments, collected data may be accumulated during a data stockpiling **2138** component of a cyber kill chain.

In certain embodiments, a cyber kill chain may likewise include a denial of service (DoS) component, which may include various actions and efforts on the part of an attacker to disrupt normal access for users and systems. In certain embodiments, such disruption may be performed to stop a cyberattack from being detected, monitored, tracked, or blocked. In certain embodiments, the data exfiltration **2140** component of a cyber kill chain may include various actions and efforts to get data out of a compromised system.

In certain embodiments, information associated with the execution of a particular component or phase of a cyber kill chain may be associated with a corresponding security vulnerability scenario **1060**, described in greater detail herein. In certain embodiments, one of more components of a particular cyber kill chain may be associated with one or more corresponding security related use cases, likewise described in greater detail herein. In certain embodiments, performance or execution of a component or phase of a cyber kill chain may be disrupted by affecting completion of the security related risk use case. Those of skill in the art will recognize that many such embodiments are possible. Accordingly, the foregoing is not intended to limit the spirit, scope, or intent of the invention.

In various embodiments, certain user entity behaviors may be observed as the result of security related activities being enacted during an associated activity session **1110**, described in greater detail herein. In certain embodiments, a user entity behavior may also be determined to be a concerning behavior, likewise described in greater detail herein. In various embodiments, as described in greater detail herein, certain IOBs associated with each activity session **1110** may be processed to generate a corresponding session fingerprint **1112**. As likewise described in greater detail herein, each resulting session fingerprint **1112** may then be associated in certain embodiments with a corresponding security vulnerability scenario **1060**. In certain embodiments, as described in greater detail herein, individual security vulnerability scenarios **1060** may in turn be associated with a particular component or phase of a cyber kill chain, such as the data theft kill chain components **2130** shown in FIG. **21**. Likewise, as described in greater detail herein, individual kill chain components may in turn be associated with a particular security risk persona, such as the data theft security risk persona **2150** shown in FIG. **21**.

As an example, as shown in FIG. **21**, security related activities enacted by a user entity during activity session(s) 'A' **2110** may be processed to generate session fingerprint(s) 'A' **2120**, which may then be associated with security vulnerability scenario 'A' **2172**. In turn, security vulnerabil-

ity scenario 'A' 2172 may be associated with the data reconnaissance 2132 phase of the data theft kill chain 2130. In this example, the security related activities may include external searches, application searching, share searching and mapping, internal searches, and so forth.

As another example, security related activities enacted by a user entity during activity session(s) 'B' 2112 may be processed to generate session fingerprint(s) 'B' 2122, which may then be associated with security vulnerability scenario 'B' 2174. In turn, security vulnerability scenario 'B' 2174 may in turn be associated with the data access 2134 phase of the data theft kill chain 2130. In this example, the security related activities may include cloud access and internal application requests, data repository access, file sharing attempts, and so forth.

As yet another example, security related activities enacted by a user entity during activity session(s) 'C' 2114 may be processed to generate session fingerprint(s) 'C' 2124, which may then be associated with security vulnerability scenario 'C' 2176. In turn, security vulnerability scenario 'C' 2176 may in turn be associated with the data collection 2136 phase of the data theft kill chain 2130. In this example, the security related activities may include cloud and web downloads, email and chat attachments, data downloads from applications, data repositories, and file shares, and so forth.

As yet still another example, security related activities enacted by a user entity during activity session(s) 'D' 2116 may be processed to generate session fingerprint(s) 'D' 2126, which may then be associated with security vulnerability scenario 'D' 2178. In turn, security vulnerability scenario Tr 2178 may in turn be associated with the data stockpiling 2138 phase of the data theft kill chain 2130. In this example, the security related activities may include creation of new folders or cloud sites, uploads to data repositories, creation of new archives, endpoints, file shares, or network connections, and so forth.

As an additional example, security related activities enacted by a user entity during activity session(s) 'E' 2118 may be processed to generate session fingerprint(s) 'E' 2128, which may then be associated with security vulnerability scenario 'E' 2180. In turn, security vulnerability scenario 'E' 2180 may in turn be associated with the data exfiltration 2140 phase of the data theft kill chain 2130. In this example, the security related activities may include flash drive and file transfers, sharing links in cloud applications, external or web-based email communication, connection to Internet of Things (IoT) infrastructures, and so forth.

In various embodiments, certain components or phases of a cyber kill chain, such as the components of the data theft kill chain 2130 shown in FIG. 21, may be associated with a corresponding security risk persona, such as the data theft security risk personas 2150, likewise shown in FIG. 21. For example, the data reconnaissance 2132, data access 2134, data collection 2136, data stockpiling 2138, and data exfiltration 2140 phases of the data theft kill chain 2130 may respectively be associated with the wanderer 2152, boundary pusher 2154, hoarder/collector 2156, stockpile 2158, and exfiltrator 2160 data theft security risk personas 2150. Accordingly, a security risk persona may be implemented in certain embodiments to align with a corresponding cyber kill chain phase. As an example, the data theft security risk persona 2150 of wanderer 2152 may be aligned with the data theft kill chain phase 2130 of data reconnaissance 2132.

In certain embodiments, a security risk persona may be named, stylized, or otherwise implemented, to convey a sense of the general behavioral theme of an associated user entity. As an example, the data theft security risk persona

2150 of boundary pusher 2154 may convey, characterize, or otherwise represent a concerning behavioral pattern of a particular user entity attempting to access certain proprietary data. Accordingly, the data theft security risk persona 2150 of boundary pusher 2154 may be implemented to align with the data theft kill chain 2130 phase of data access 2134.

In certain embodiments, a security risk persona may be implemented to describe, or otherwise indicate, an associated user entity's behavior at a particular point in time, and by extension, provide an indication of their motivation, or intent, or both. Accordingly, a security risk persona may be implemented in certain embodiments to provide an indication of a user entity's current phase in a particular cyber kill chain, or possibly multiple cyber kill chains. In certain embodiments, the alignment of a security risk persona to a corresponding phase of a cyber kill chain may be used to accurately map a particular security risk persona to user entity behavior in a way that clarifies cyber kill chain phases and associated security vulnerability scenarios. In certain embodiments, a user entity may exhibit multiple types, or categorizations, of user entity behavior, such that they behaviorally and historically align with multiple security risk personas over the same interval of time.

In certain embodiments, the ordering of security risk personas may indicate a progression of the severity of the user entity behaviors associated with each phase of a cyber kill chain. In certain embodiments, a user entity's associated security risk persona may traverse a particular cyber kill chain over time. In certain embodiments, such traversal of a cyber kill chain may be non-linear, or bi-directional, or both. In certain embodiments, tracking the transition of a user entity's associated security risk persona over time may provide an indication of their motivation, or intent, or both.

As an example, as shown in FIG. 21, the data theft security persona 2150 of a user entity may initially be that of a hoarder/collector 2156. In this example, the user entity's data theft security persona 2150 may transition to boundary pusher 2154 and wanderer 2152. Alternatively, the user entity's data theft security persona 2150 may transition directly to wanderer 2152, and from there, to boundary pusher 2154. As yet another alternative, the user entity's data theft security persona 2150 may transition directly to exfiltrator 2160, and so forth. Skilled practitioners of the art will recognize that many such possibilities of a security risk persona traversing a cyber kill chain are possible. Accordingly, the foregoing is not intended to limit the spirit, scope, or intent of the invention.

FIGS. 22a and 22b show indicators of behavior corresponding to a security risk persona implemented in accordance with an embodiment of the invention. In certain embodiments, a security risk persona 2028 may be typified by a descriptor characterizing its associated indicators of behavior (IOBs) 1108, described in greater detail herein. In various embodiments, IOBs 1108 associated with a particular security risk persona 2028 may occur during a certain period of time 2208. In various embodiments, a security risk persona's 2208 associated IOBs 1108 may correspond to the occurrence of certain events 2210 at certain points of time 2208.

As an example, as shown in FIG. 22a, a user entity may exhibit a group of IOBs 1108 typically associated with the security risk persona 2028 of "Leaver" 2214. To continue the example, the group of IOBs 1108 may include the creation of multiple resume variations, updating of social media profiles, researching companies via their websites, searching for real estate in a new location, increased documentation of work product, and so forth. Likewise, associ-

ated events **2210** may include preparing for a job search, searching, applying, and interviewing for a new job, following up with a potential employer, negotiating compensation, reviewing an offer, completing a background check, tendering notice, and leaving the organization.

Accordingly, certain embodiments of the invention reflect an appreciation that not all IOBs **1108** are concerning behaviors, described in greater detail herein. Furthermore, certain embodiments reflect an appreciation that such user entity behaviors may include simple mistakes or inadvertently risky activities, and as such, are not explicitly linked to a malicious objective. Various embodiments of the invention likewise reflect an appreciation that while certain IOBs **1108** may not explicitly be concerning behaviors, they may represent some degree of security risk.

In various embodiments, certain human factors **430**, described in greater detail herein, may be implemented to act as security risk “force multipliers,” by encouraging or accelerating the formation of a particular security risk persona **2028**. In various embodiments, the identification of certain human factors associated with a particular user entity may be implemented to apply additional weight to a risk security score corresponding to the user entity. In certain embodiments, the security risk score may be associated with a particular IOB **1108**, or a particular security risk score **2028**, associated with the user entity.

In various embodiments, as likewise described in greater detail herein, such human factors **430** may include certain cardinal traits **1402**, emotional stressors **1404**, and organizational dynamics **1406**. For example, as shown in FIG. **22a**, professional **1706** emotional stressors **1404** may include unsatisfactory performance reviews or compensation, co-worker friction, unmet expectations, cancelled projects, and so forth. Personal **1704** emotional stressors **1404** may likewise include certain life changes, such as health issues, the birth, death, or sickness of a family member or friend, separation or divorce, relocation to a new locale, and so forth.

Financial **1708** emotional stressors **1404** may likewise include bankruptcy, foreclosure, credit issues, gambling issues, and so forth, while legal **1710** emotional stressors **1404** may include previous arrests, current arrests or incarceration, drug/DUI offenses, wage garnishment, and so forth. Likewise, organizational dynamics **1406** human factors **430** may include changes in management, reorganizations, mergers, acquisitions, downsizing, site closures, changes in work policies, declines in stock prices, and so forth. Those of skill in the art will recognize that many such examples are possible. Accordingly, the foregoing is not intended to limit the spirit, scope, or intent of the invention.

FIG. **23** shows a functional block diagram of process flows associated with the operation of security analytics system implemented in accordance with an embodiment of the invention. In certain embodiments, a security analytics system **118**, described in greater detail herein, may be implemented with an EBC system **120**, a human factors framework **122**, and a risk scoring system **124**, or a combination thereof, as likewise described in greater detail herein. In certain embodiments, the EBC system **120** may be implemented to define and manage an entity behavior profile (EBP) **420**, as described in greater detail herein. In certain embodiments, the EBP **420** may be implemented to include a user entity profile **422**, a non-user entity profile **440**, a data entity profile **450**, and an entity state **462**, or a combination thereof, as likewise described in greater detail herein. In certain embodiments, the user entity profile **422** may be

implemented to include certain human factors **430** and user entity mindset profile **632** information, as described in greater detail herein.

In certain embodiments, EBC system **120** operations are begun with the receipt of information associated with an initial event **i 2302**. In various embodiments, information associated with an initial event **i 2302** may include user entity profile **422** attributes, user entity behavior factor information, user entity mindset profile **632** information, entity state **462** information, certain contextual and temporal information, all described in greater detail herein, or a combination thereof. In various embodiments, certain user entity profile **422** data, user entity mindset profile **632** data, non-user entity profile **440** data, entity state **462** data, contextual information, and temporal information stored in a repository of EBC data **540** may be retrieved and then used to perform event enrichment **2308** operations to enrich the information associated with event **i 2302**.

Analytic utility detection **2310** operations are then performed on the resulting enriched event **i 2302** to determine whether it is of analytic utility. If so, then it is derived as an observable **1106**, described in greater detail herein. In certain embodiments, event **i+1 2304** through event **i+n 2306**, may in turn be received by the EBC system **120** and be enriched **2308**. Analytic utility detection **2310** operations are then performed on the resulting enriched event **i+1 2304** through event **i+n 2306** to determine whether they are of analytic utility. Observables **1106** are then derived from those that are.

In various embodiments, certain indicator of behavior (IOB) abstraction **2314** operations may be performed on the resulting observables **1106** corresponding to events **i 2302**, **i+1 2304**, and **i+n 2306** to generate an associated IOB **1108**, described in greater detail herein. In various embodiments, an IOB **1108** may be expressed in a Subject→Action→Object format and associated with observables **1106** resulting from event information provided by various received from certain EBC data sources, likewise described in greater detail herein. In certain embodiments, an IOB abstraction **2314** operation may be performed to abstract away EBC data source-specific knowledge and details when expressing an entity behavior. For example, rather than providing the details associated with a “Windows:4624” non-user entity event, its details may be abstracted to a “User Login To Device” IOB **1108**.

In various embodiments, sessionization and fingerprint **1020** operations, described in greater detail herein, may be performed on event information corresponding to events **i 2302**, **i+1 2304**, **i+n 2306**, their corresponding observables **1306**, and their associated IOBs **1108**, or a combination thereof, to generate session information. In various embodiments, the resulting session information may be used to associate certain events **i 2302**, **i+1 2304**, **i+n 2306**, or their corresponding observables **2306**, or their corresponding IOBs **1108**, or a combination thereof, with a particular session.

In certain embodiments, as likewise described in greater detail herein, one or more IOBs **1108** may in turn be associated with a corresponding EBP element. In various embodiments, the previously-generated session information may be used to associate the one or more IOBs **1108** with a particular EBP element. In certain embodiments, the one or more IOBs **1108** may be associated with its corresponding EBP element through the performance of an EBP management operation performed by the EBC system **120**. Likewise, in certain embodiments, one or more EBP elements

may in turn be associated with the EBP 420 through the performance of an EBP management operation performed by the EBC system 120.

In various embodiments, certain contextualization information stored in the repository of EBC data 540 may be retrieved and then used to perform entity behavior contextualization 2318 operations to provide entity behavior context, based upon the entity's user entity profile 422, or a non-user entity profile 440, or a data entity 450, and their respectively associated entity state 462, or a combination thereof. In various embodiments, certain security risk use case association 1050 operations may be performed to associate an EBP 420 with a particular security risk use case, described in greater detail herein. In certain embodiments, the results of the previously-performed entity behavior contextualization 2318 operations may be used to perform the security risk use case association 1050 operations.

In various embodiments, security vulnerability scenario inference 1060 operations may be performed to associate a security risk use case with a particular security vulnerability scenario, described in greater detail herein. In various embodiments, certain observables 1106 derived from events of analytic utility may be used to perform the security vulnerability scenario inference 1060 operations. In various embodiments, certain entity behavior contexts resulting from the performance of the entity behavior contextualization 2318 operations may be used to perform the security vulnerability scenario inference 1060 operations.

In certain embodiments, entity behavior meaning derivation 1532 operations may be performed on the security vulnerability behavior scenario selected as a result of the performance of the security vulnerability scenario inference 1060 operations to derive meaning from the behavior of the entity. In certain embodiments, the entity behavior meaning derivation 1532 operations may be performed by the human factors framework 122. In certain embodiments, the human factors framework 122 may be implemented to receive a stream of human factors information 406, as described in greater detail herein. In certain embodiments, the human factors framework 122 may be implemented to process the stream of human factors information 406 to derive certain human factors 430, and once derived, store them in an associated user entity profile 422. In certain embodiments, the human factors framework 122 may be implemented to perform the entity behavior meaning derivation 1532 operation in combination with the EBC system 120.

In certain embodiments, the entity behavior meaning derivation 1532 operations may be performed by analyzing the contents of the EBP 420 in the context of the security vulnerability behavior scenario selected as a result of the performance of the security vulnerability scenario inference 1060 operations. In certain embodiments, the human factors framework 122 may be implemented to perform the entity behavior meaning derivation 1532 operations by analyzing certain information contained in the EBP 420. In certain embodiments, the human factors framework 122 may be implemented to perform the entity behavior meaning derivation 1532 operations by analyzing certain human factors 430 and user entity mindset profile 632 information stored in the user entity profile 422 to derive the intent of a particular user entity behavior. In certain embodiments, the derivation of entity behavior meaning may include inferring the intent of an entity associated with event i 2302 and event $i+1$ 2304 through event $i+n$ 2306.

In various embodiments, performance of the entity behavior meaning derivation 1354 operations may result in the performance of a security risk assessment operation,

described in greater detail herein. In certain embodiments, the security risk assessment operation may be performed to assess the security risk associated with the enactment of a particular user entity behavior. In certain embodiments, the security risk assessment operation may be implemented as a human factors 430 risk assessment operation, described in greater detail herein. In various embodiments, the risk scoring system 124 may be implemented to perform the security risk assessment operation. In certain embodiments, the risk scoring system 124 may be implemented to use certain security risk assessment information resulting from the performance of a security risk assessment operation to generate a security risk score.

In certain embodiments, a security risk score meeting certain security risk parameters may result in the performance of an associated security operation 470, described in greater detail herein. In certain embodiments, the security operation 470 may include a cyber kill chain 2352 operation, or a risk-adaptive protection 2354 operation, or both. In certain embodiments, the cyber kill chain 2352 operation may be performed to disrupt the execution of a cyber kill chain, described in greater detail herein. In certain embodiments, the risk-adaptive protection 2352 operation may include adaptively responding with an associated risk-adaptive response, as described in greater detail herein.

In various embodiments, the security operation 470 may include certain risk mitigation operations being performed by a security administrator. As an example, performance of the security operation 470 may result in a notification being sent to a security administrator alerting them to the possibility of suspicious behavior. In certain embodiments, the security operation 470 may include certain risk mitigation operations being automatically performed by a security analytics system or service. As an example, performance of the security operation 470 may result in a user's access to a particular system being disabled if an attempted access occurs at an unusual time or from an unknown device.

In certain embodiments, meaning derivation information associated with event i 2302 may be used to update the user entity profile 420, non-user entity profile 440, or data entity profile 450 corresponding to the entity associated with event i 2302. In certain embodiments, the process is iteratively repeated, proceeding with meaning derivation information associated with event $i+1$ 2304 through event $i+n$ 2306. From the foregoing, skilled practitioners of the art will recognize that a user entity profile 420, non-user entity profile 440, or data entity profile 450, or some combination thereof, as implemented in certain embodiments, not only allows the identification of events associated with a particular entity that may be of analytic utility, but also provides higher-level data that allows for the contextualization of observed events. Accordingly, by viewing individual sets of events both in context and with a view to how they may be of analytic utility, it is possible to achieve a more nuanced and higher-level comprehension of an entity's intent.

FIGS. 24a and 24b show a simplified block diagram of a distributed security analytics system environment implemented in accordance with an embodiment of the invention. In various embodiments, the distributed security analytics system environment may be implemented to perform certain human factors risk operations, as described in greater detail herein. In various embodiments, the distributed security analytics system environment may be implemented to use certain human factors information to assess the security risk corresponding to a particular indicator of behavior (IOB), as likewise described in greater detail herein. In certain embodiments, the distributed security analytics mapping

system environment may be implemented to include a security analytics system **118**, described in greater detail herein. In certain embodiments, the security analytics system **118** may be implemented to include an entity behavior catalog (EBC) system **120**, a human factors framework **122**, and a security risk scoring system **124**, or a combination thereof.

In various embodiments, the human factors framework **122** may be implemented to provide certain human factors information, described in greater detail herein, to the security analytics system **118**. In various embodiments, the security analytics system **118** may be implemented to use such human factors information to perform certain human factors risk operations, likewise described in greater detail herein. In various embodiments, certain human factors risk operations performed by the security analytics system **118** may be used to assess the security risk associated with a corresponding IOB, as described in greater detail herein. In certain embodiments, the security risk corresponding to a particular IOB may be associated with one or more user entities, likewise as described in greater detail herein.

In certain embodiments, as likewise described in greater detail herein, the EBC system **120**, the human factors framework **122**, and the security risk scoring system **124**, or a combination thereof, may be used in combination with the security analytics system **118** to perform such human factors risk operations. In various embodiments, certain data stored in a repository of event data **530**, EBC data **540**, security analytics **550** data, or a repository of security risk scoring data **560**, or a combination thereof, may be used by the security analytics system **118**, the EBC system **120**, the human factors framework **122**, or the risk scoring system **124**, or some combination thereof, to perform the human factors risk operation.

In various embodiments, the EBC system **120**, as described in greater detail herein, may be implemented to use certain entity behavior information and associated event data, to generate an entity behavior profile (EBP), as described in greater detail herein. In various embodiments, the security analytics system **118** may be implemented to use one or more session-based fingerprints to perform security analytics operations to detect certain user, non-user, or data entity behavior, as likewise described in greater detail herein. In certain embodiments, the security analytics system **118** may be implemented to monitor entity behavior associated with a user entity, such as a user 'A' **710** or user 'B' **712**. In certain embodiments, the user, non-user, or data entity behavior, or a combination thereof, may be monitored during user/device **930**, user/network **942**, user/resource **948**, and user/user **920** interactions. In certain embodiments, the user/user **920** interactions may occur between a first user entity, such as user 'A' **710** and a second user entity, such as user 'B' **912**.

In certain embodiments, the human factors framework **122** may be implemented to perform a human factors risk operation, described in greater detail herein. In various embodiments, as likewise described in greater detail herein, the human factors framework **122** may be implemented to use certain associated event information to perform the human factors risk operation. In certain embodiments, the event information may be stored in a repository of event **530** data. In various embodiments, the security risk scoring system **124** may be implemented to provide certain security risk scoring information stored in the repository of security risk scoring **560** data to the security analytics system **118** for use by the human factors framework **122**.

In various embodiments, the human factors framework **122** may be implemented, as described in greater detail herein, to manage certain human factors information relevant to the occurrence of an IOB. In various embodiments, as likewise described in greater detail herein, the human factors framework **122** may be implemented to provide certain human factors information relevant to the occurrence of a particular IOB to the EBC system **120**, or the risk scoring system **124**, or both. In certain embodiments, the human factors information provided by the human factors framework **122** to the EBC system **120**, or the security risk scoring system **124**, or both, may be used to assess the security risk associated with the occurrence of a particular indicator of behavior.

In certain embodiments, as described in greater detail herein, an endpoint agent **206** may be implemented on an endpoint device **204** to perform user, non-user, or data entity behavior monitoring. In certain embodiments, the user, non-user, or data entity behavior may be monitored by the endpoint agent **206** during user/device **930** interactions between a user entity, such as user 'A' **710**, and an endpoint device **204**. In certain embodiments, the user, non-user, or data entity behavior may be monitored by the endpoint agent **206** during user/network **942** interactions between user 'A' **710** and a network, such as a network **140** or third party network **310**. In certain embodiments, the user, non-user, or data entity behavior may be monitored by the endpoint agent **206** during user/resource **948** interactions between user 'A' **710** and a resource **950**, such as a facility, printer, surveillance camera, system, datastore, service, and so forth.

In certain embodiments, the monitoring of user or non-user entity behavior by the endpoint agent **206** may include the monitoring of electronically-observable actions, or associated behavior, respectively enacted by a particular user, non-user, or data entity. In certain embodiments, the endpoint agent **206** may be implemented in combination with the security analytics system **118**, the EBC system **120**, the human factors framework **122**, and the security risk scoring system **124**, or a combination thereof, to detect an IOB, assess its associated risk, and perform a security operation to mitigate risk, or a combination thereof.

In certain embodiments, the endpoint agent **206** may be implemented to include an event counter feature pack **2408**, an event analytics **210** module, a human factors framework **2422** module, and a security risk scoring **2424** module, or a combination thereof. In certain embodiments, the event counter feature pack **2408** may be further implemented to include an event data detector **2410** module, an event counter **2412** module, and an event data collector **2414** module, or a combination thereof. In certain embodiments, the event analytics **210** module may be implemented to include a security policy rule **2416** engine, an event of analytic utility **2418** module, and an IOB detection **2420** module, or a combination thereof.

In certain embodiments, the event data detector **2410** module may be implemented to detect event data associated with a particular endpoint device **204**, as described in greater detail herein, resulting from user/device **930**, user/network **942**, user/resource **948**, and user/user **920** interactions. In various embodiments, the event counter **2412** module may be implemented to collect, or otherwise track, the occurrence of certain events, or classes of events, resulting from user/device **930**, user/network **942**, user/resource **948**, and user/user **920** interactions.

In various embodiments, the event data collector **2414** module may be implemented to collect certain event data associated with the user/device **930**, user/network **942**, user/

61

resource **948**, and user/user **920** interactions. In certain embodiments, the security policy rule **2416** engine may be implemented to manage security policy information relevant to determining whether a particular event is of analytic utility, anomalous, or both. In certain embodiments, the event of analytic utility detection **2418** module may be implemented to detect an event of analytic utility associated with events corresponding to the user/device **930**, user/network **942**, user/resource **948**, and user/user **920** interactions.

In various embodiments, the event of analytic utility detection **2418** module may be implemented to use certain security policy information provided by the security policy rule **2416** engine to determine whether a particular event associated with an endpoint device **204** is of analytic utility. In certain embodiments, the security policy rule **2416** engine may be implemented to determine whether a particular event of analytic utility associated with an endpoint device **204** is anomalous.

In various embodiments, the IOB detection **2420** module may be implemented to perform certain IOB detection operations associated with events of analytic utility corresponding to the user/device **930**, user/network **942**, user/resource **948**, and user/user **920** interactions. In various embodiments, the event of analytic utility detection **2418** module may be implemented to provide certain information associated with one or more events of analytic utility to the IOB **2420** module. In certain embodiments, the event of analytic utility detection **2418** module may be implemented to determine whether the one or more events of analytic utility are associated with one another.

In various embodiments, the IOB detection **2420** module may be implemented to use such information in the performance of certain IOB detection operations, which in turn may result in the detection of an IOB. In certain embodiments, the endpoint agent **206** may be implemented to communicate the event and associated event counter data collected by the event data collector **2414** module, data associated with the events of analytic utility detected by the event of analytic utility detection **2418** module, and information associated with the IOBs detected by the IOB detection **2420** module, or a combination thereof, to the security analytics **118** system or another component of the distributed security analytics system environment.

In certain embodiments, the human factors framework **2422** module may be implemented to perform a human factors risk operation, as described in greater detail herein. In various embodiments, the human factors framework **2422** module may be implemented to provide certain human factors information to one or more other components of the distributed security analytics system environment. In certain embodiments, the security risk scoring system **2424** may be implemented to generate a security risk score, likewise described in greater detail, for an IOB corresponding to one or more events detected by the IOB detection **2420** module.

In certain embodiments, the security risk scoring system **2424** may be implemented to generate a security risk score corresponding to a particular IOB when it is first detected. In certain embodiments, the security risk score corresponding to a particular IOB may be used as a component in the generation of a security risk score for an associated user entity. In certain embodiments, the endpoint agent **206** may be implemented to provide one or more security risk scores to one or more other components of the distributed security analytics system environment.

In certain embodiments, an edge device **304** may be implemented to include an edge device risk module **2406**. In

62

certain embodiments, the edge device risk module **2406** may be implemented to include an event detection **2428** system, a human factors framework **2442** module, a security risk scoring system **2444**, or a combination thereof. In certain embodiments, the event detection **2428** system may be implemented to include an event data detector **2430** module, an event counter **2432** module, an event data collector **2434** module, a security policy rule **2436** engine, an event of analytic utility **2438** module, and an IOB detection **2440** module, or a combination thereof.

In certain embodiments, the event data detector **2430** module may be implemented to detect event data associated with a particular edge device **204**, as described in greater detail herein, resulting from user/device **930**, user/network **942**, user/resource **948**, and user/user **920** interactions. In various embodiments, the event counter **2432** module may be implemented to collect, or otherwise track, the occurrence of certain events, or classes of events, resulting from user/device **930**, user/network **942**, user/resource **948**, and user/user **920** interactions.

In various embodiments, the event data collector **2430** module may be implemented to collect certain event data associated with the user/device **930**, user/network **942**, user/resource **948**, and user/user **920** interactions. In certain embodiments, the security policy **2436** engine may be implemented to manage security policy information relevant to determining whether a particular event is of analytic utility, anomalous, or both. In certain embodiments, the event of analytic utility detection **2438** module may be implemented to detect an event of analytic utility associated with events corresponding to the user/device **930**, user/network **942**, user/resource **948**, and user/user **920** interactions.

In various embodiments, the event of analytic utility detection **2438** module may be implemented to use certain security policy information provided by the security policy rule **2436** engine to determine whether a particular event associated with an edge device **304** is of analytic utility. In certain embodiments, the security policy rule **2436** engine may be implemented to determine whether a particular event of analytic utility associated with an edge device **304** is anomalous.

In various embodiments, the IOB detection **2440** module may be implemented to perform certain IOB detection operations, described in greater detail herein, associated with events of analytic utility corresponding to the user/device **930**, user/network **942**, user/resource **948**, and user/user **920** interactions. In various embodiments, the event of analytic utility detection **2438** module may be implemented to provide certain information associated with one or more events of analytic utility to the IOB detection **2440** module. In certain embodiments, the event of analytic utility detection **2438** module may be implemented to determine whether the one or more events of analytic utility are associated with one another.

In various embodiments, the IOB detection **2440** module may be implemented to use such information in the performance of certain IOB detection operations, which in turn may result in the detection of an IOB. In certain embodiments, the edge device risk module **2406** may be implemented to communicate the event and associated event counter data collected by the event data collector **2434** module, data associated with the events of analytic utility detected by the event of analytic utility detection **2438** module, and information associated with the IOBs detected by the IOB detection **2440** module, or a combination

thereof, to the security analytics **118** system or another component of the distributed security analytics system environment.

In certain embodiments, the human factors framework **2442** module may be implemented to perform a human factors risk operation, as described in greater detail herein. In various embodiments, the human factors framework **2442** may be implemented to provide certain human factors information to one or more other components of the distributed security analytics system environment. In certain

embodiments, the security risk scoring system **2444** may be implemented to generate a security risk score, likewise described in greater detail, for an IOB corresponding to one or more events detected by the IOB detection **2440** module. In certain embodiments, the security risk scoring system **2444** may be implemented to generate a security risk score corresponding to a particular IOB when it is first detected. In certain embodiments, the security risk score corresponding to a particular IOB may be used as a component in the

generation of a security risk score for an associated user entity. In certain embodiments, the edge device risk module **2406** may be implemented to provide one or more security risk scores to one or more other components of the distributed security analytics system environment. In certain embodiments, a third party system **312** may be implemented to include a third party system risk module **2426**. In certain embodiments, the third party system risk module **2426** may be implemented to include an event detection **2448** system, a human factors framework **2462** module, and a security risk scoring system **2464**, or a combination thereof. In certain embodiments, the event detection **2448** system may be implemented to include an event data detector **2450** module, an event counter **2452** module, an event data collector **2454** module, a security policy rule **2456** engine, an event of analytic utility **2458** module, and an IOB detection **2460** module, or a combination thereof.

In certain embodiments, the event data detector **2450** module may be implemented to detect event data associated with a particular third party system **312** resulting from user/device **930**, user/network **942**, user/resource **948**, and user/user **920** interactions. In various embodiments, the event counter **2452** module may be implemented to collect, or otherwise track, the occurrence of certain events, or classes of events, as described in greater detail herein, resulting from user/device **930**, user/network **942**, user/resource **948**, and user/user **920** interactions.

In various embodiments, the event data collector **2450** module may be implemented to collect certain event data associated with the user/device **930**, user/network **942**, user/resource **948**, and user/user **920** interactions. In certain embodiments, the security policy rule **2456** engine may be implemented to manage security policy information relevant to determining whether a particular event is of analytic utility, anomalous, or both. In certain embodiments, the event of analytic utility detection **258** module may be implemented to detect an event of analytic utility associated with events corresponding to the user/device **930**, user/network **942**, user/resource **948**, and user/user **920** interactions.

In various embodiments, the event of analytic utility detection **2458** module may be implemented to use certain security policy information provided by the security policy rule **2456** engine to determine whether a particular event associated with a third party system **312** is of analytic utility. In certain embodiments, the security policy rule **2456** engine

may be implemented to determine whether a particular event of analytic utility associated with a third party system **312** is anomalous.

In various embodiments, the IOB detection **2460** module may be implemented to perform certain IOB detection operations associated with events of analytic utility corresponding to the user/device **930**, user/network **942**, user/resource **948**, and user/user **920** interactions. In various embodiments, the event of analytic utility detection **2458** module may be implemented to provide certain information associated with one or more events of analytic utility to the IOB detection **2460** module. In certain embodiments, the event of analytic utility detection **2458** module may be implemented to determine whether the one or more events of analytic utility are associated with one another.

In various embodiments, the IOB detection **2460** module may be implemented to use such information in the performance of certain IOB detection operations, which in turn may result in the detection of an IOB. In certain embodiments, the third party system risk module **2426** may be implemented to communicate the event and associated event counter data collected by the event data collector **2454** module, data associated with the events of analytic utility detected by the event of analytic utility detection **2458** module, and information associated with the IOBs detected by the IOB detection **2460** module, or a combination thereof, to the security analytics **118** system or another component of the distributed security analytics mapping system environment.

In certain embodiments, the human factors framework **2462** module may be implemented to perform a human factors risk operation, as described in greater detail herein. In various embodiments, human factors framework **2462** module may be implemented to provide certain human factors information to one or more other components of the distributed security analytics system environment. In certain embodiments, the security risk scoring system **2464** may be implemented to generate a security risk score, likewise described in greater detail, for an IOB corresponding to one or more events detected by the IOB detection **2464** module.

In certain embodiments, the security risk scoring system **2464** may be implemented to generate a security risk score corresponding to a particular IOB when it is first detected, as likewise described in greater detail herein. In certain embodiments, the security risk score corresponding to a particular IOB may be used as a component in the generation of a security risk score for an associated user entity. In certain embodiments, the third party system risk module **2426** may be implemented to provide one or more security risk scores to one or more other components of the distributed security analytics environment.

In certain embodiments, the security analytics system **118** may be implemented to receive the event data, the event counter data, the data associated with the detected events of analytic utility and IOBs, or a combination thereof, provided by the endpoint agent **206**, the edge device risk module **2406**, and the third party system risk module **2426**, or a combination thereof. In certain embodiments, the security analytics system **118** may be implemented to provide the event data and event counter data, the data associated with the detected endpoint events of analytic utility and events, or a combination thereof, to the EBC system **120**, the human factors framework **122**, and the security risk scoring system **124** for processing.

In certain embodiments, the EBC system **120** may be implemented to include an EBP element generator **2466** module, an EBP session generator **2468** module, an EBP

generator **2470** module, or a combination thereof. In various embodiments, the EBP element generator **2466** module may be implemented to process event and event counter data, along with data associated with events of analytic utility and anomalous events, provided by the endpoint agent **206** to generate EBP elements, described in greater detail herein. In certain embodiments, the EBP session generator **2468** may be implemented to use the event and endpoint event counter, data associated with events of analytic utility and anomalous events provided by the endpoint agent **206**, to generate session information. In certain embodiments, the EBP session generator **2468** may be implemented to use the resulting session information to generate an activity session, described in greater detail herein. In various embodiments, as likewise described in greater detail herein, certain EBP management operations may be performed to associate EBP elements generated by the EBP element generator **2468** module with a corresponding EBP. Likewise, certain EBP management operations may be performed to use the session information generated by the EBP session generator **2470** module to associate a particular EBP element with a particular EBP.

In certain embodiments, the event detection system **2472** may be implemented to include an event data detector **2474** module, an event counter **2476** module, an event data collector **2478** module, a security policy rule **2480** engine, an event of analytic utility **2484** module, and an IOB detection **2484** module, or a combination thereof. In certain embodiments, the event data detector **2474** module may be implemented to detect event data associated with a particular endpoint device **204**, edge device **304**, or third party system **312**, as described in greater detail herein, resulting from user/device **930**, user/network **942**, user/resource **948**, and user/user **920** interactions. In various embodiments, the event counter **2476** module may be implemented to collect, or otherwise track, the occurrence of certain events, or classes of events, as described in greater detail herein, resulting from user/device **930**, user/network **942**, user/resource **948**, and user/user **920** interactions.

In various embodiments, the event data collector **2474** module may be implemented to collect certain event data associated with the user/device **930**, user/network **942**, user/resource **948**, and user/user **920** interactions. In certain embodiments, the security policy rule **2480** engine may be implemented to manage security policy information relevant to determining whether a particular event is of analytic utility, anomalous, or both. In certain embodiments, the event of analytic utility detection **2482** module may be implemented to detect an event of analytic utility associated with events corresponding to the user/device **930**, user/network **942**, user/resource **948**, and user/user **920** interactions.

In various embodiments, the event of analytic utility detection **2482** module may be implemented to use certain security policy information provided by the security policy rule **2480** engine to determine whether a particular event associated with a particular endpoint device **204**, edge device **304**, or third party system **312** is of analytic utility. In certain embodiments, the security policy rule **2480** engine may be implemented to determine whether a particular event of analytic utility associated with an endpoint device **204**, edge device **304**, or third party system **312** is anomalous.

In various embodiments, the IOB detection **2484** module may be implemented to perform certain IOB detection operations associated with events of analytic utility corresponding to the user/device **930**, user/network **942**, user/resource **948**, and user/user **920** interactions. In various

embodiments, the event of analytic utility detection **2482** module may be implemented to provide certain information associated with one or more events of analytic utility to the IOB detection **2484** module. In certain embodiments, the event of analytic utility detection **2482** module may be implemented to determine whether the one or more events of analytic utility are associated with one another.

In various embodiments, the IOB detection **2484** module may be implemented to use such information in the performance of certain IOB detection operations, which in turn may result in the detection of an IOB. In certain embodiments, the event detection system **2472** may be implemented to communicate the event and associated event counter data collected by the event data collector **2478** module, data associated with the events of analytic utility detected by the event of analytic utility detection **2482** module, and information associated with the IOBs detected by the IOB detection **2484** module, or a combination thereof, to another component of the distributed security analytics system environment.

In certain embodiments, the human factors framework **122** may be implemented to perform a human factors risk operation, as described in greater detail herein. In various embodiments, the human factors framework **122** may be implemented to provide certain human factors information to one or more other components of the distributed security analytics mapping system environment. In certain embodiments, the security risk scoring system **124** may be implemented to generate a security risk score, likewise described in greater detail, for an IOB corresponding to one or more events detected by the IOB detection **2484** module.

In certain embodiments, the security risk scoring system **124** may be implemented to generate a security risk score corresponding to a particular IOB when it is first detected, as likewise described in greater detail herein. In certain embodiments, the security risk score corresponding to a particular IOB may be used as a component in the generation of a security risk score for an associated user entity. In certain embodiments, the security risk scoring system **124** may be implemented to provide one or more security risk scores to one or more other components of the distributed security analytics system environment. Those of skill in the art will recognize that many such implementations are possible. Accordingly, the foregoing is not intended to limit the spirit, scope, or intent of the invention.

FIGS. **25a** and **25b** show tables containing human factors-centric risk model data used to generate a user entity risk score associated with a security vulnerability scenario implemented in accordance with an embodiment of the invention for an example data theft scenario. In certain embodiments, as described in greater detail herein, security risk personas **2508** associated with a particular security vulnerability scenario **1060** may be assigned a median risk score **2510**. For example, as shown in FIGS. **25a** and **25b**, a security risk persona **2508** of “Boundary Pusher” may be assigned a median risk score **2510** of ‘20’ for the security vulnerability scenario **1060** of “Data Theft.”

In certain embodiments, a concerning behavior risk score **2518** may be generated for a particular user entity exhibiting concerning behaviors typically associated with a corresponding security risk persona **2508** during a calendar interval **2520** of time. In certain embodiments, the concerning behavior risk score **2518** may be adjusted according to the user entity’s enduring behavior pattern **1642** and the median risk score **2510** corresponding to the security risk persona **2508** currently associated with the user entity. In certain embodiments, certain human factors **430** may be

applied to the concerning behavior risk score **2518** to generate an associated user entity risk score **2530**.

For example, as shown in FIG. **25b**, a user entity may be exhibiting concerning behaviors associated with a security risk persona **2508** of "Hoarder/Collector" associated with a security vulnerability scenario **1060** of "Data Theft" during the calendar interval **2520** of the second half of July. In this example, the user entity's enduring behavior pattern **1642** is "Hoarder/Collector," signifying that the user entity's long-term predisposition is to collect and hoard information. Accordingly, the median risk score **2510** of '20' associated with the security risk persona **2508** of "Hoarder/Collector" may be used to generate a concerning behavior risk score **2518** of '30.' To continue the example, the resulting concerning behavior risk score **2818** of '30' is then respectively adjusted by cardinal factors **1402**, emotional stressor **1404**, and organizational dynamics **1406** human factors **430** to yield a user entity risk score **2530** of '49.'

FIG. **26** shows a user interface (UI) window implemented in accordance with an embodiment of the invention to graphically display an entity risk score as it changes over time. In certain embodiments, changes in a user entity's entity risk score **2630** over an interval of time, such as calendar intervals **2620**, may be displayed within a window of a graphical user interface (GUI) **2602**, such as that shown in FIG. **26**.

As will be appreciated by one skilled in the art, the present invention may be embodied as a method, system, or computer program product. Accordingly, embodiments of the invention may be implemented entirely in hardware, entirely in software (including firmware, resident software, microcode, etc.) or in an embodiment combining software and hardware. These various embodiments may all generally be referred to herein as a "circuit," "module," or "system." Furthermore, the present invention may take the form of a computer program product on a computer-usable storage medium having computer-usable program code embodied in the medium.

Any suitable computer usable or computer readable medium may be utilized. The computer-usable or computer-readable medium may be, for example, but not limited to, an electronic, magnetic, optical, electromagnetic, infrared, or semiconductor system, apparatus, or device. More specific examples (a non-exhaustive list) of the computer-readable medium would include the following: a portable computer diskette, a hard disk, a random access memory (RAM), a read-only memory (ROM), an erasable programmable read-only memory (EPROM or Flash memory), a portable compact disc read-only memory (CD-ROM), an optical storage device, or a magnetic storage device. In the context of this document, a computer-usable or computer-readable medium may be any medium that can contain, store, communicate, or transport the program for use by or in connection with the instruction execution system, apparatus, or device.

Computer program code for carrying out operations of the present invention may be written in an object oriented programming language such as Java, Smalltalk, C++ or the like. However, the computer program code for carrying out operations of the present invention may also be written in conventional procedural programming languages, such as the "C" programming language or similar programming languages. The program code may execute entirely on the user's computer, partly on the user's computer, as a stand-alone software package, partly on the user's computer and partly on a remote computer or entirely on the remote computer or server. In the latter scenario, the remote computer may be connected to the user's computer through a

local area network (LAN) or a wide area network (WAN), or the connection may be made to an external computer (for example, through the Internet using an Internet Service Provider).

Embodiments of the invention are described with reference to flowchart illustrations and/or block diagrams of methods, apparatus (systems) and computer program products according to embodiments of the invention. It will be understood that each block of the flowchart illustrations and/or block diagrams, and combinations of blocks in the flowchart illustrations and/or block diagrams, can be implemented by computer program instructions. These computer program instructions may be provided to a processor of a general purpose computer, special purpose computer, or other programmable data processing apparatus to produce a machine, such that the instructions, which execute via the processor of the computer or other programmable data processing apparatus, create means for implementing the functions/acts specified in the flowchart and/or block diagram block or blocks.

These computer program instructions may also be stored in a computer-readable memory that can direct a computer or other programmable data processing apparatus to function in a particular manner, such that the instructions stored in the computer-readable memory produce an article of manufacture including instruction means which implement the function/act specified in the flowchart and/or block diagram block or blocks.

The computer program instructions may also be loaded onto a computer or other programmable data processing apparatus to cause a series of operational steps to be performed on the computer or other programmable apparatus to produce a computer implemented process such that the instructions which execute on the computer or other programmable apparatus provide steps for implementing the functions/acts specified in the flowchart and/or block diagram block or blocks.

The present invention is well adapted to attain the advantages mentioned as well as others inherent therein. While the present invention has been depicted, described, and is defined by reference to particular embodiments of the invention, such references do not imply a limitation on the invention, and no such limitation is to be inferred. The invention is capable of considerable modification, alteration, and equivalents in form and function, as will occur to those ordinarily skilled in the pertinent arts. The depicted and described embodiments are examples only, and are not exhaustive of the scope of the invention.

Consequently, the invention is intended to be limited only by the spirit and scope of the appended claims, giving full cognizance to equivalents in all respects.

What is claimed is:

1. A computer-implementable method for performing a security operation, comprising:
 - 55 monitoring an entity, the monitoring observing at least one electronically-observable data source;
 - deriving an observable based upon the monitoring of the electronically-observable data source;
 - 60 associating human factors with the entity, the human factors comprising a cardinal trait, an emotional stressor and an organizational dynamic, the cardinal trait comprising a representation of a particular enduring behavioral pattern corresponding to the entity that is persisted over a time period, the emotional stressor comprising a contextual modifier, the contextual modifier providing context when analyzing security related activity, the organizational dynamic comprising an

electronically-observable event occurring within an organization having an operational influence on a behavior of the entity, the organizational dynamic comprising one or more of a security practice organizational dynamic, a communication issue organizational dynamic, a management system organizational dynamic, and a work planning and control organizational dynamic; 5

identifying an event of analytic utility, the event of analytic utility being derived from the observable from the electronic data source; 10

analyzing the event of analytic utility, the analyzing the event of analytic utility using the human factors associated with the entity enacting the event of analytic utility; 15

generating a risk score in response to the analyzing, the generating the risk score using the human factors associated with the entity; and,

performing the security operation when the risk score meets a security risk parameter, the security operation comprising a human factor risk operation, the human factor risk operation being performed by a security analytics system executing on a hardware processor. 20

2. The method of claim 1, wherein:

the human factor risk operation comprises detecting a behavior and identifying the behavior as a concerning behavior by processing information associated with the human factor with information associated with an indicator of behavior. 25

3. The method of claim 2, wherein:

the human factor risk operation uses the concerning behavior to infer an adverse effect associated with the event of analytic utility. 30

4. The method of claim 1, further comprising:

performing an entity behavior meaning derivation operation, the entity behavior meaning derivation operation providing an understanding of a meaning of the event of analytic utility; and, 35

using the understanding of the meaning of the event of analytic utility when performing the security operation. 40

5. The method of claim 4, wherein:

the entity behavior meaning derivation operation analyzes the human factor and a user entity mindset profile to derive an intent of the entity.

6. A system comprising: 45

a processor;

a data bus coupled to the processor; and

a non-transitory, computer-readable storage medium embodying computer program code for performing a security operation, the non-transitory, computer-readable storage medium being coupled to the data bus, the computer program code interacting with a plurality of computer operations and comprising instructions executable by the processor and configured for: 50

monitoring an entity, the monitoring observing at least one electronically-observable data source; 55

deriving an observable based upon the monitoring of the electronically-observable data source;

associating human factors with the entity, the human factors comprising a cardinal trait, an emotional stressor and an organizational dynamic, the cardinal trait comprising a representation of a particular enduring behavioral pattern corresponding to the entity that is persisted over a time period, the emotional stressor comprising a contextual modifier, the contextual modifier providing context when analyzing security related activity, the organizational 60

65

dynamic comprising an electronically-observable event occurring within an organization having an operational influence on a behavior of the entity, the organizational dynamic comprising one or more of a security practice organizational dynamic, a communication issue organizational dynamic, a management system organizational dynamic, and a work planning and control organizational dynamic; identifying an event of analytic utility, the event of analytic utility being derived from the observable from the electronic data source;

analyzing the event of analytic utility, the analyzing the event of analytic utility using the human factors associated with the entity enacting the event of analytic utility;

generating a risk score in response to the analyzing, the generating the risk score using the human factors associated with the entity; and,

performing the security operation when the risk score meets a security risk parameter, the security operation comprising a human factor risk operation, the human factor risk operation being performed by a security analytics system executing on a hardware processor.

7. The system of claim 6, wherein:

the human factor risk operation comprises detecting a behavior and identifying the behavior as a concerning behavior by processing information associated with the human factor with information associated with an indicator of behavior.

8. The system of claim 7, wherein:

the human factor risk operation uses the concerning behavior to infer an adverse effect associated with the event of analytic utility.

9. The system of claim 6, wherein the instructions executable by the processor are further configured for:

performing an entity behavior meaning derivation operation, the entity behavior meaning derivation operation providing an understanding of a meaning of the event of analytic utility; and,

using the understanding of the meaning of the event of analytic utility when performing the security operation.

10. The system of claim 9, wherein:

the entity behavior meaning derivation operation analyzes the human factor and a user entity mindset profile to derive an intent of the entity.

11. A non-transitory, computer-readable storage medium embodying computer program code for performing a security operation, the computer program code comprising computer executable instructions configured for:

monitoring an entity, the monitoring observing at least one electronically-observable data source;

deriving an observable based upon the monitoring of the electronically-observable data source;

associating human factors with the entity, the human factors comprising a cardinal trait, an emotional stressor and an organizational dynamic, the cardinal trait comprising a representation of a particular enduring behavioral pattern corresponding to the entity that is persisted over a time period, the emotional stressor comprising a contextual modifier, the contextual modifier providing context when analyzing security related activity, the organizational dynamic comprising an electronically-observable event occurring within an organization having an operational influence on a behavior of the entity, the organizational dynamic comprising one or more of a security practice organiza-

71

tional dynamic, a communication issue organizational dynamic, a management system organizational dynamic, and a work planning and control organizational dynamic;

identifying an event of analytic utility, the event of analytic utility being derived from the observable from the electronic data source;

analyzing the event of analytic utility, the analyzing the event of analytic utility using the human factors associated with the entity enacting the event of analytic utility;

analyzing the event of analytic utility, the analyzing the event of analytic utility using the human factors associated with the entity enacting the event of analytic utility;

performing the security operation when the risk score meets a security risk parameter, the security operation comprising a human factor risk operation, the human factor risk operation being performed by a security analytics system executing on a hardware processor.

12. The non-transitory, computer-readable storage medium of claim **11**, wherein:

the human factor risk operation comprises detecting a behavior and identifying the behavior as a concerning behavior by processing information associated with the human factor with information associated with an indicator of behavior.

72

13. The non-transitory, computer-readable storage medium of claim **12**, wherein:

the human factor risk operation uses the concerning behavior to infer an adverse effect associated with the event of analytic utility.

14. The non-transitory, computer-readable storage medium of claim **11**, wherein the computer executable instructions are further configured for:

performing an entity behavior meaning derivation operation, the entity behavior meaning derivation operation providing an understanding of a meaning of the event of analytic utility; and,

using the understanding of the meaning of the event of analytic utility when performing the security operation.

15. The non-transitory, computer-readable storage medium of claim **14**, wherein:

the entity behavior meaning derivation operation analyzes the human factor and a user entity mindset profile to derive an intent of the entity.

16. The non-transitory, computer-readable storage medium of claim **11**, wherein:

the computer executable instructions are deployable to a client system from a server system at a remote location.

17. The non-transitory, computer-readable storage medium of claim **11**, wherein:

the computer executable instructions are provided by a service provider to a user on an on-demand basis.

* * * * *